

Small signal Schottky diodes

Main product characteristics

I_F	150 mA
V_{RRM}	100 V
C (typ)	6 pF
T_j (max)	150° C

Features and benefits

- Very small conduction losses
- Negligible switching losses
- Low forward voltage drop
- Surface mount device

Description

Diodes in the BAT46 series are high voltage, small signal Schottky diodes suited for protection and routing operations.

Order codes

Part Number	Marking
BAT46ZFILM	Z46
BAT46FILM	S46
BAT46AFILM	A46
BAT46CFILM	C46
BAT46SFILM	B46
BAT46WFILM	D46
BAT46AWFILM	DB6
BAT46CWFILM	DB8
BAT46SWFILM	B46
BAT46JFILM	46

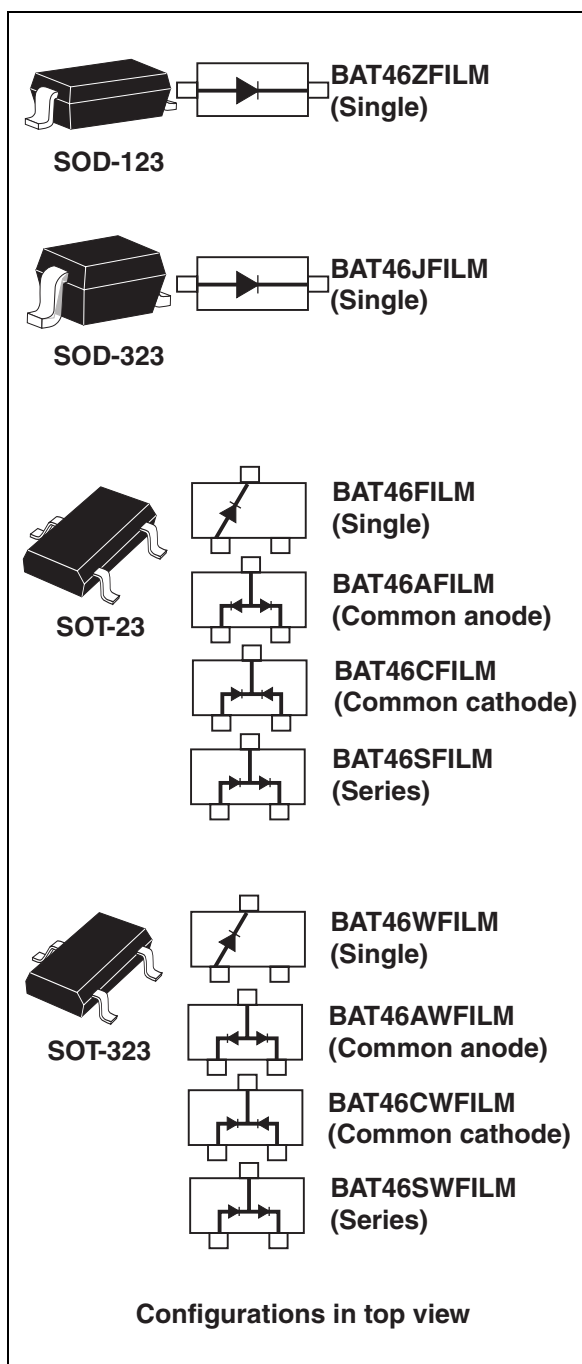

1 Characteristics

Table 1. Absolute ratings (limiting values at $T_j = 25^\circ\text{C}$, unless otherwise specified)

Symbol	Parameter	Value	Unit
V_{RRM}	Repetitive peak reverse voltage	100	V
I_F	Continuous forward current	150	mA
I_{FSM}	Surge non repetitive forward current	$t_p = 10\text{ ms}$ Sinusoidal	A
T_{stg}	Storage temperature range	-65 to +150	$^\circ\text{C}$
T_j	Maximum operating junction temperature ⁽¹⁾	150	$^\circ\text{C}$
T_L	Maximum soldering temperature ⁽¹⁾	260	$^\circ\text{C}$

1. Pulse test: $t_p = 380\ \mu\text{s}$, $\delta < 2\%$

Table 2. Thermal parameters

Symbol	Parameter	Value	Unit
$R_{th(j-a)}$	Junction to ambient ⁽¹⁾	SOD-123, SOT-23	500
		SOT-323, SOD-323,	550
			$^\circ\text{C/W}$

1. On epoxy printed circuit board with recommended pad layout

Table 3. Static electrical characteristics

Symbol	Parameter	Test conditions	Min.	Typ	Max.	Unit
$I_R^{(1)}$	Reverse leakage current	$T_j = 25^\circ\text{C}$	$V_R = 1.5\text{ V}$		0.5	μA
			$V_R = 10\text{ V}$		0.8	
			$V_R = 50\text{ V}$		2	
			$V_R = 75\text{ V}$		5	
		$T_j = 60^\circ\text{C}$	$V_R = 1.5\text{ V}$		5	
			$V_R = 10\text{ V}$		7.5	
			$V_R = 50\text{ V}$		15	
			$V_R = 75\text{ V}$		20	
$V_F^{(2)}$	Forward voltage drop	$T_j = 25^\circ\text{C}$	$I_F = 0.1\text{ mA}$		0.25	V
			$I_F = 10\text{ mA}$		0.45	
			$I_F = 250\text{ mA}$		1	

1. Pulse test: $t_p = 5\text{ ms}$, $\delta < 2\%$

2. Pulse test: $t_p = 380\ \mu\text{s}$, $\delta < 2\%$

Table 4. Dynamic characteristics

Symbol	Parameter	Test conditions	Min.	Typ	Max.	Unit
C	Diode capacitance	$V_R = 0\text{ V}$, $F = 1\text{ MHz}$		10		pF
		$V_R = 1\text{ V}$, $F = 1\text{ MHz}$		6		

Figure 1. Average forward power dissipation versus average forward current

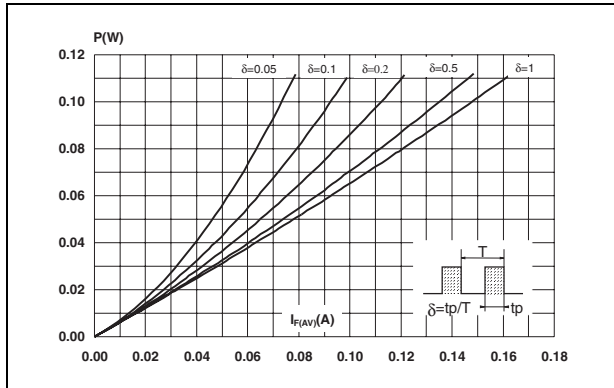

Figure 2. Average forward current versus ambient temperature ($\delta = 1$)

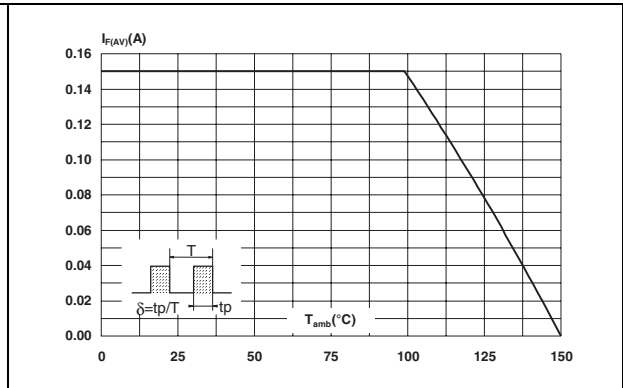

Figure 3. Reverse leakage current versus reverse applied voltage (typical values)

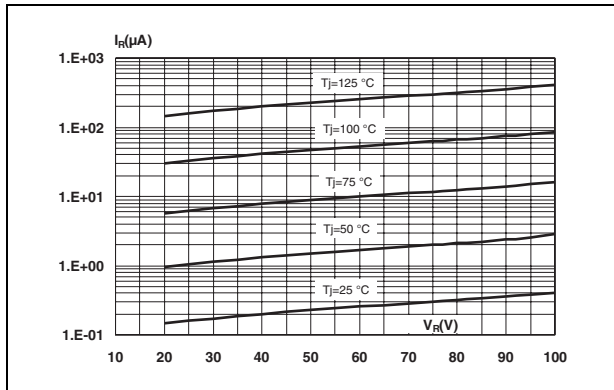

Figure 4. Reverse leakage current versus junction temperature

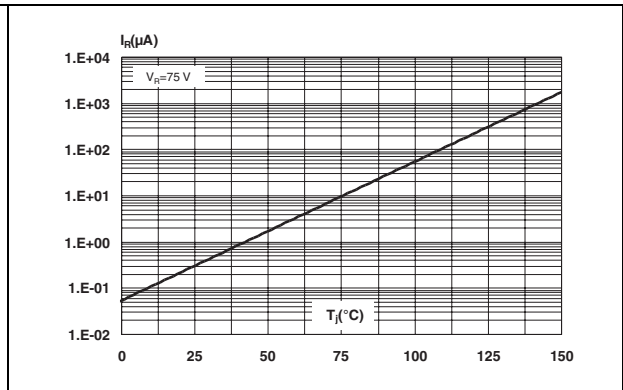

Figure 5. Junction capacitance versus reverse applied voltage (typical values)

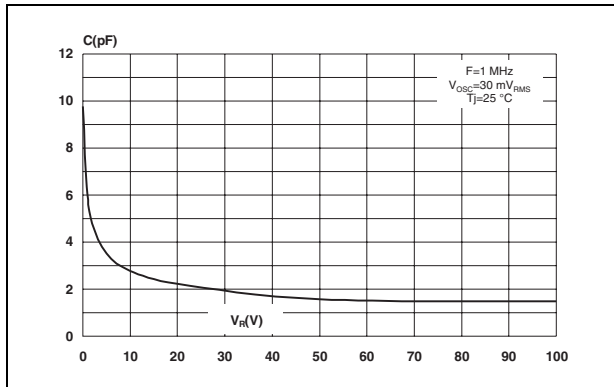

Figure 6. Forward voltage drop versus forward current (typical values, low-level)

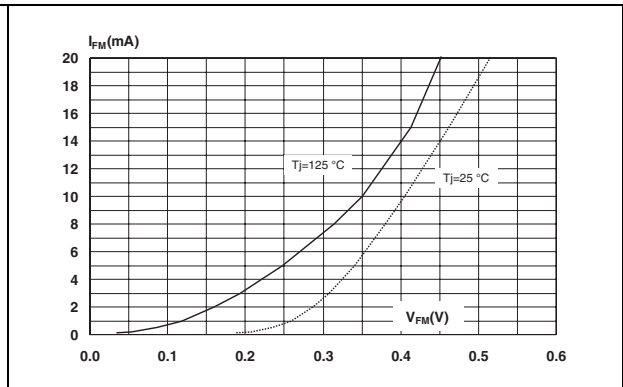

Figure 7. Forward voltage drop versus forward current (typical values, high-level)

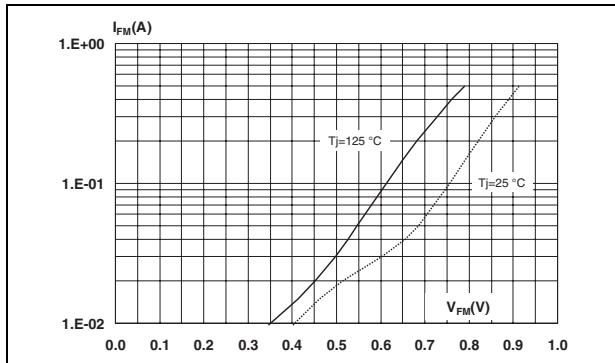

Figure 8. Relative variation of thermal impedance junction to ambient versus pulse duration - printed circuit board, epoxy FR4 $e_{CU} = 35 \mu m$ (SOD-323)

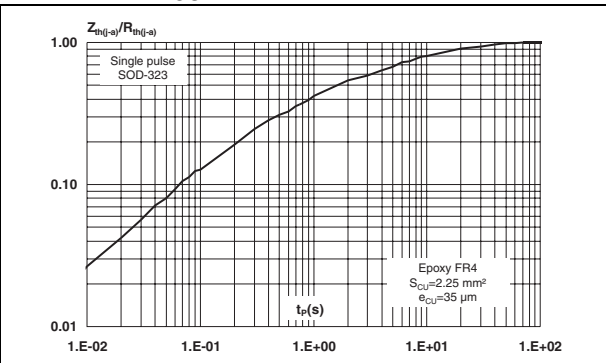

Figure 9. Relative variation of thermal impedance junction to ambient versus pulse duration - aluminium oxide substrate 10 mm x 8 mm x 0.5 mm (SOT-23)

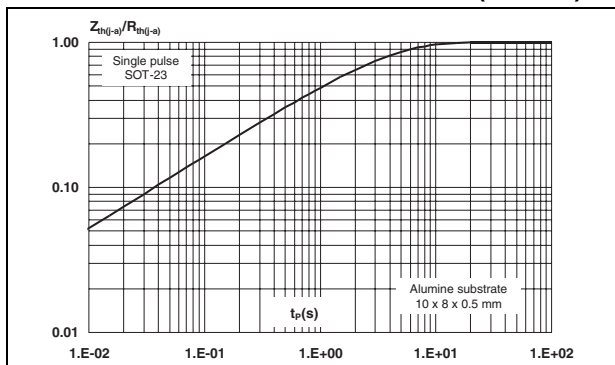

Figure 10. Variation of thermal impedance junction to ambient versus pulse duration - printed circuit board, epoxy FR4, $e_{CU} = 35 \mu m$ (SOT-323)

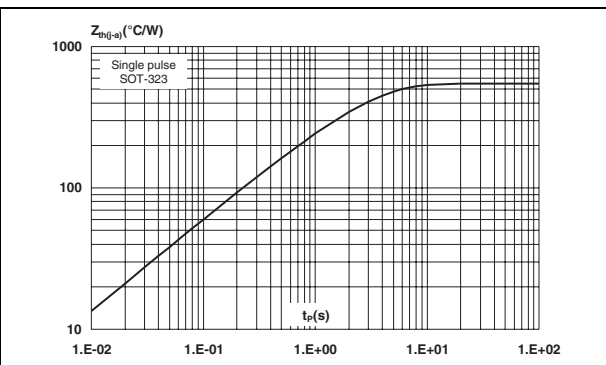
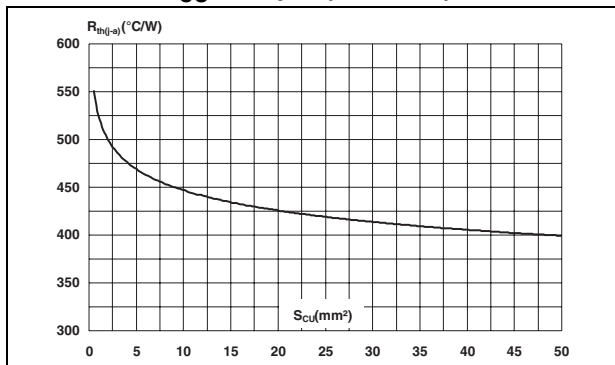
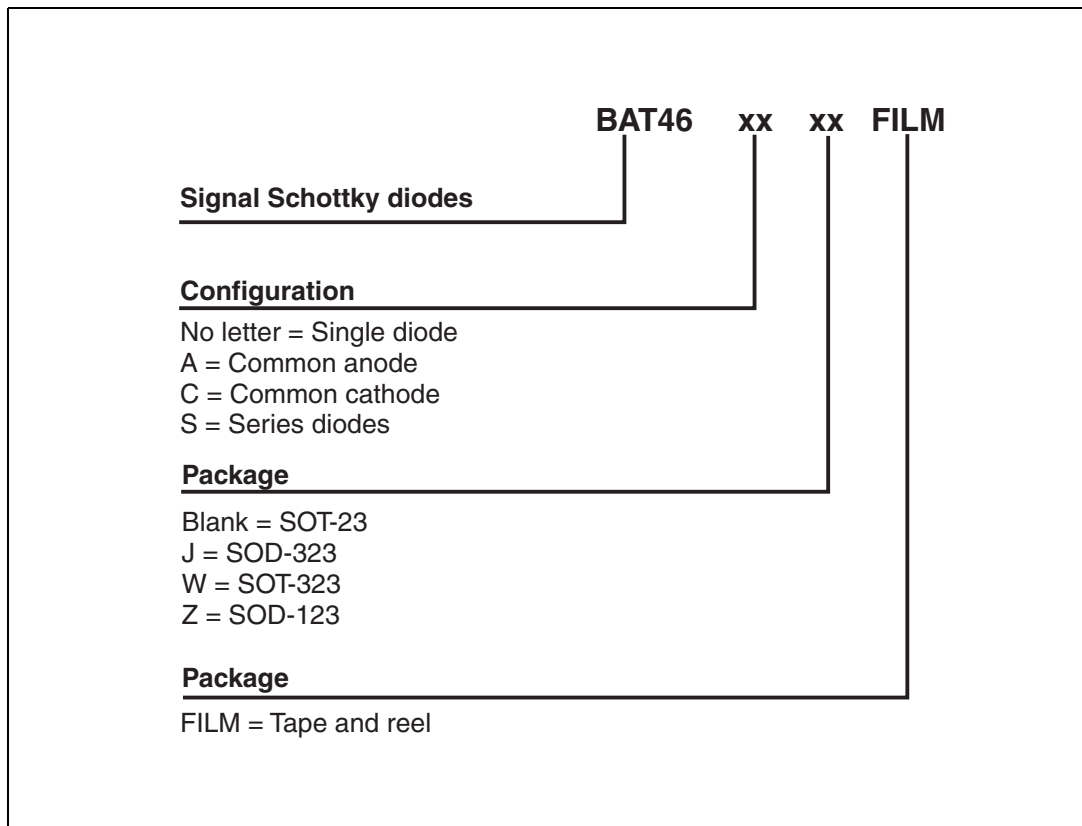

Figure 11. Thermal resistance junction to ambient versus copper surface under each lead, epoxy FR4, $e_{CU} = 35 \mu m$ (SOD-323)



2 Ordering information scheme



3 Package information

Epoxy meets UL94, V0

Table 5. SOD-123 dimensions

Ref.	Dimensions			
	Millimeters		Inches	
	Min.	Max.	Min.	Max.
A		1.45		0.057
A1	0	0.1	0	0.004
A2	0.85	1.35	0.033	0.053
b	0.55 Typ.		0.022 Typ.	
c	0.15 Typ.		0.039 Typ.	
D	2.55	2.85	0.1	0.112
E	1.4	1.7	0.055	0.067
G	0.25		0.01	
H	3.55	3.95	0.14	0.156

Figure 12. SOD-123 footprint (dimensions in mm)

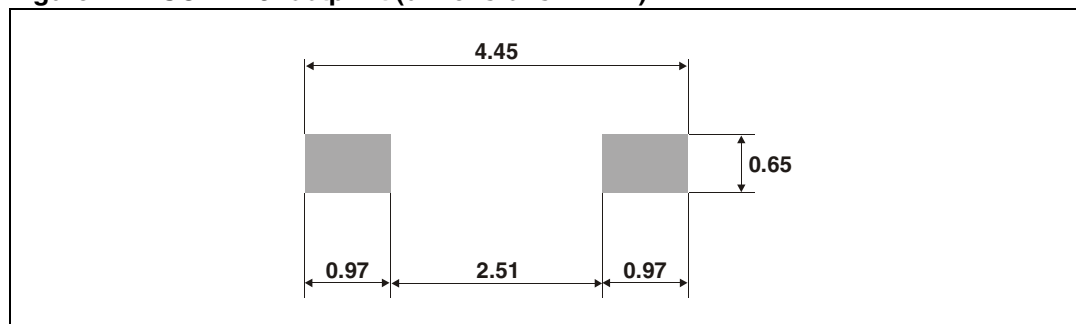

Table 6. SOD-323 dimensions

Ref.	Dimensions			
	Millimeters		Inches	
	Min.	Max.	Min.	Max.
A		1.17		0.046
A1	0	0.1	0	0.004
b	0.25	0.44	0.01	0.017
c	0.1	0.25	0.004	0.01
D	1.52	1.8	0.06	0.071
E	1.11	1.45	0.044	0.057
H	2.3	2.7	0.09	0.106
L	0.1	0.46	0.004	0.02
Q1	0.1	0.41	0.004	0.016

Figure 13. SOD-323 footprint (dimensions in mm)

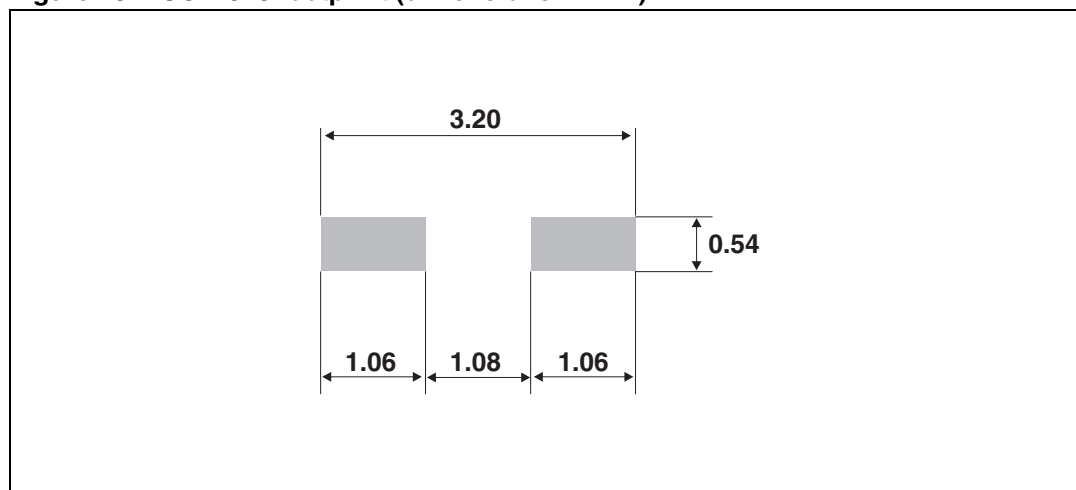

Table 7. SOT-23 dimensions

Ref.	Dimensions			
	Millimeters		Inches	
	Min.	Max.	Min.	Max.
A	0.89	1.4	0.035	0.055
A1	0	0.1	0	0.004
B	0.3	0.51	0.012	0.02
c	0.085	0.18	0.003	0.007
D	2.75	3.04	0.108	0.12
e	0.85	1.05	0.033	0.041
e1	1.7	2.1	0.067	0.083
E	1.2	1.6	0.047	0.063
H	2.1	2.75	0.083	0.108
L	0.6 typ.		0.024 typ.	
S	0.35	0.65	0.014	0.026

Figure 14. SOT-23 footprint (dimensions in mm)

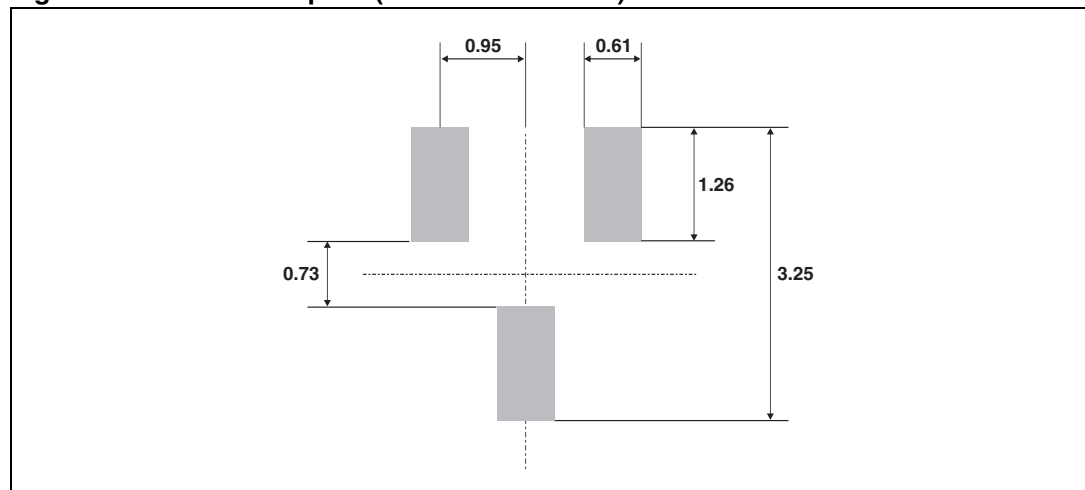
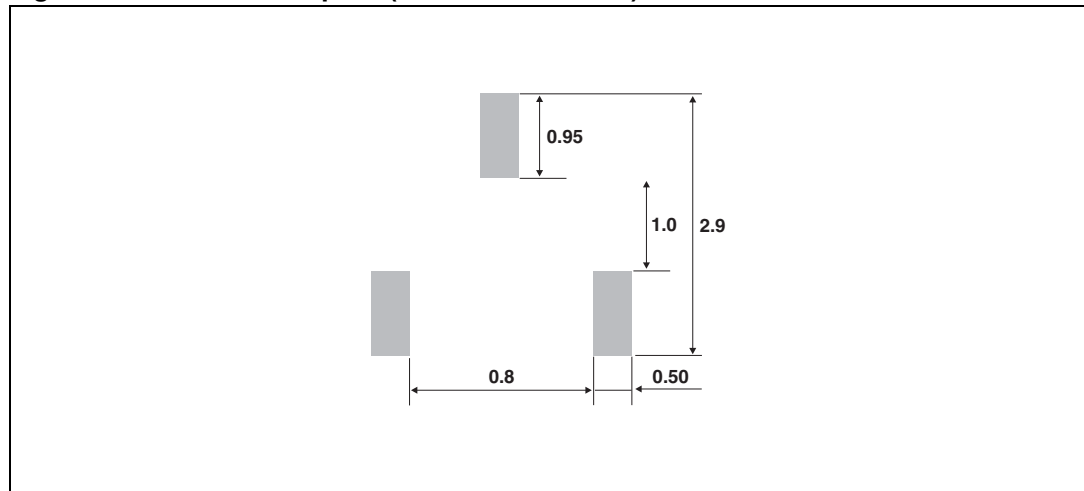

Table 8. SOT-323 dimensions

Ref.	Dimensions					
	Millimeters			Inches		
	Min.	Typ.	Max.	Min.	Typ.	Max.
A	0.8		1.1	0.031		0.043
A1	0.0		0.1	0.0		0.004
b	0.25		0.4	0.010		0.016
c	0.1		0.26	0.004		0.010
D	1.8	2.0	2.2	0.071	0.079	0.086
E	1.15	1.25	1.35	0.045	0.049	0.053
e		0.65			0.026	
H	1.8	2.1	2.4	0.071	0.083	0.094
L	0.1	0.2	0.3	0.004	0.008	0.012
q	0		30°	0		30°

Figure 15. SOT-323 footprint (dimensions in mm)



In order to meet environmental requirements, ST offers these devices in ECOPACK® packages. These packages have a lead-free second level interconnect. The category of second level interconnect is marked on the package and on the inner box label, in compliance with JEDEC Standard JESD97. The maximum ratings related to soldering conditions are also marked on the inner box label. ECOPACK is an ST trademark. ECOPACK specifications are available at: www.st.com.

4 Ordering information

Part Number	Marking	Package	Weight	Base qty	Delivery mode
BAT46ZFILM	Z46	SOD-123 Single	10 mg	3000	Tape and reel
BAT46FILM	S46	SOT-23 Single	10 mg	3000	Tape and reel
BAT46AFILM	A46	SOT-23 Common anode	10 mg	3000	Tape and reel
BAT46CFILM	C46	SOT-23 Common cathode	10 mg	3000	Tape and reel
BAT46SFILM	B46	SOT-23 Series	10 mg	3000	Tape and reel
BAT46WFILM	D46	SOT-323 Single	6 mg	3000	Tape and reel
BAT46AWFILM	DB6	SOT-323 Common anode	6 mg	3000	Tape and reel
BAT46CWFILM	DB8	SOT-323 Common cathode	6 mg	3000	Tape and reel
BAT46SWFILM	B46	SOT-323 Series	6 mg	3000	Tape and reel
BAT46JFILM	46	SOD-323	5 mg	3000	Tape and reel

5 Revision history

Date	Revision	Description of Changes
Jun-1999	3	Previous revision.
25-Jul-2006	4	BAT46Z, J, W datasheets merged. ECOPACK statement added.

Please Read Carefully:

Information in this document is provided solely in connection with ST products. STMicroelectronics NV and its subsidiaries ("ST") reserve the right to make changes, corrections, modifications or improvements, to this document, and the products and services described herein at any time, without notice.

All ST products are sold pursuant to ST's terms and conditions of sale.

Purchasers are solely responsible for the choice, selection and use of the ST products and services described herein, and ST assumes no liability whatsoever relating to the choice, selection or use of the ST products and services described herein.

No license, express or implied, by estoppel or otherwise, to any intellectual property rights is granted under this document. If any part of this document refers to any third party products or services it shall not be deemed a license grant by ST for the use of such third party products or services, or any intellectual property contained therein or considered as a warranty covering the use in any manner whatsoever of such third party products or services or any intellectual property contained therein.

UNLESS OTHERWISE SET FORTH IN ST'S TERMS AND CONDITIONS OF SALE ST DISCLAIMS ANY EXPRESS OR IMPLIED WARRANTY WITH RESPECT TO THE USE AND/OR SALE OF ST PRODUCTS INCLUDING WITHOUT LIMITATION IMPLIED WARRANTIES OF MERCHANTABILITY, FITNESS FOR A PARTICULAR PURPOSE (AND THEIR EQUIVALENTS UNDER THE LAWS OF ANY JURISDICTION), OR INFRINGEMENT OF ANY PATENT, COPYRIGHT OR OTHER INTELLECTUAL PROPERTY RIGHT.

UNLESS EXPRESSLY APPROVED IN WRITING BY AN AUTHORIZED ST REPRESENTATIVE, ST PRODUCTS ARE NOT RECOMMENDED, AUTHORIZED OR WARRANTED FOR USE IN MILITARY, AIR CRAFT, SPACE, LIFE SAVING, OR LIFE SUSTAINING APPLICATIONS, NOR IN PRODUCTS OR SYSTEMS WHERE FAILURE OR MALFUNCTION MAY RESULT IN PERSONAL INJURY, DEATH, OR SEVERE PROPERTY OR ENVIRONMENTAL DAMAGE. ST PRODUCTS WHICH ARE NOT SPECIFIED AS "AUTOMOTIVE GRADE" MAY ONLY BE USED IN AUTOMOTIVE APPLICATIONS AT USER'S OWN RISK.

Resale of ST products with provisions different from the statements and/or technical features set forth in this document shall immediately void any warranty granted by ST for the ST product or service described herein and shall not create or extend in any manner whatsoever, any liability of ST.

ST and the ST logo are trademarks or registered trademarks of ST in various countries.

Information in this document supersedes and replaces all information previously supplied.

The ST logo is a registered trademark of STMicroelectronics. All other names are the property of their respective owners.

© 2006 STMicroelectronics - All rights reserved

STMicroelectronics group of companies

Australia - Belgium - Brazil - Canada - China - Czech Republic - Finland - France - Germany - Hong Kong - India - Israel - Italy - Japan - Malaysia - Malta - Morocco - Singapore - Spain - Sweden - Switzerland - United Kingdom - United States of America

www.st.com