



Product Name	Cement Type Resistors				
Version	A1	Enactment Date	13-07 -2012	Page	2-1

1、 Indication

- (1) Rated Power
- (2) Resistance
- (3) Tolerance

Sample:

50W 12Ω J

2、 External dimensions

2.1 AH-50type

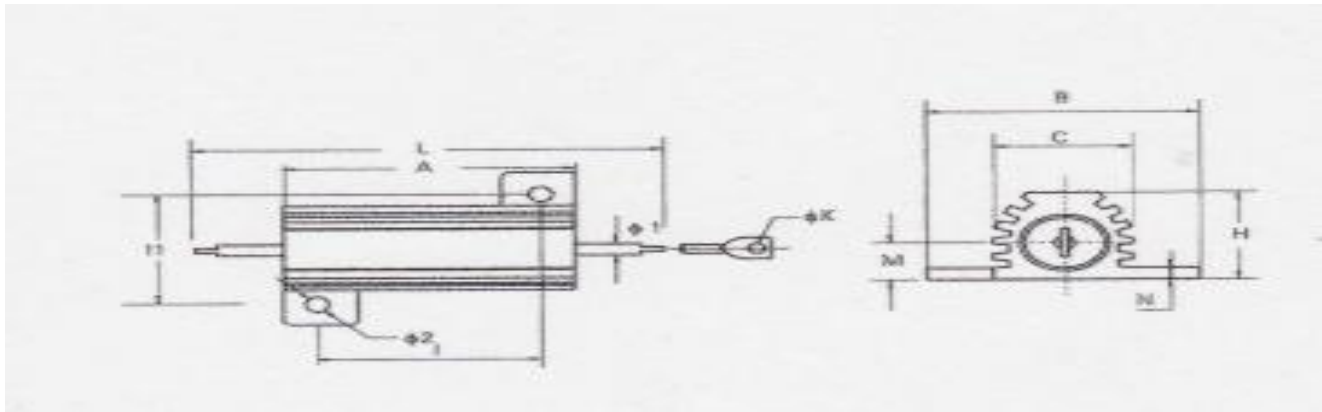

3: Graphic size

4: Resistance Technical Parameters

Power Rating	A	B	L	H	I	C	M	N
50W	50	29	71	15	40	16	7.3	2