

REVISION RECORD

REV	ECN	DESCRIPTION	DRFT	DATE
-----	-----	-------------	------	------

NOTES1:

UL Standard

- 1.Rated Voltage/Current : 300V / 10A
- 2.Withstanding Voltage : AC1600V/1Min.
- 3.Wire Range : 26~12AWG

IEC Standard

1. Pollution Degree	2
Overvoltage Category	III
Rate Impulse Voltage(KV)	4KV
Rate Voltage(V)	400V
Rate Current(A)	20A

2.Wire Range : 1.0~2.5mm²

NOTES2:

- 1.Dimension shall be interpreted per ASME Y14.5-2009
- 2.Pitch : 7.50/7.62mm, Poles : N=02-16P
- 3.Stripping length : 9~10mm
- 4.Operating temperature : -40°C~+105°C
- 5.Undimensioned Tolerances:

Pitch range in mm		Nominal dimension range in mm					0.1/10
To	Over	To	Over	To	Over		
6	10	30	60	100	150	±2'	
±0.15	±0.20	±0.30	±0.50	±0.70	±1.00		
±0.30	±0.50	±0.70	±1.00	±1.30	±1.30		

6.RoHS Compliance

2EDGKDM - 7.5/7.62 - XXP - 1Y - 00A (H)
 (Series No.) (Pitch) (Poles) (Single Pitch) (Color):1.(Grey)
 2.(Blue)
 3.(Black)
 4.(Green)
 5.(Orange)
 6.(Red)
 7.(Transparent)
 8.(Yellow)
 9.(White)

H
G
F
E
D
C
B
A

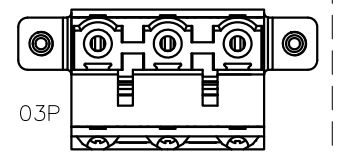
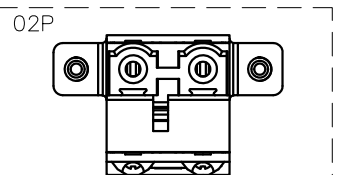
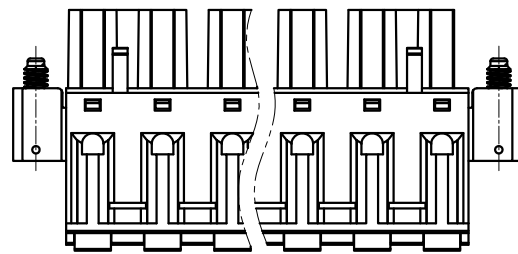
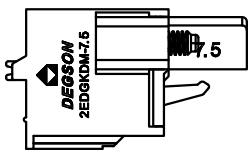
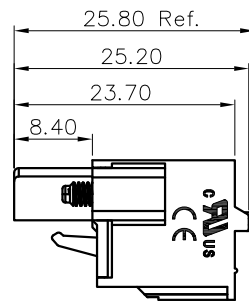
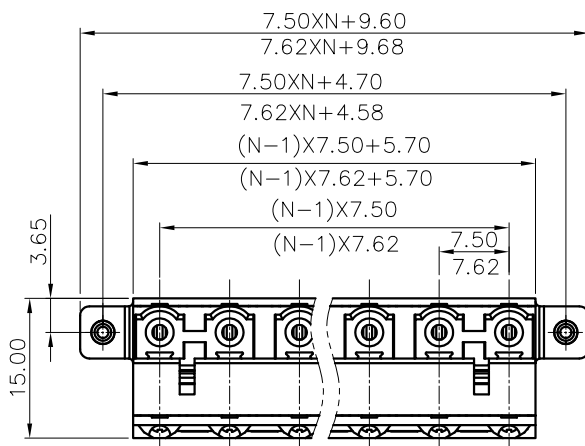
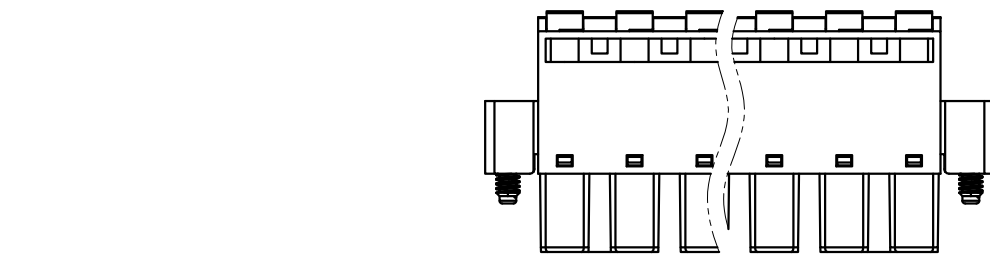

DETACHED LISTS	PART NO.:	/			
	APPD:	/			
	CHKD:	/			
	DRFT:	/			
		<p>THIRD ANGLE PROJECTION</p>		<p>MM (INCH)</p>	
		DO NOT SCALE DRAWING		SCALE	1:1

宁波高松电子有限公司
DEGSON NINGBO DEGSON ELECTRICAL CO., LTD

NAME: 2EDGKDM-7.5/7.62-XXP-1Y-00A(H)

TITLE: CUSTOMER DRAWING

DRAWING NO.: / SHEET 1/1