

V19 SERIES

32349182

Issue A

MICRO SWITCH Technology

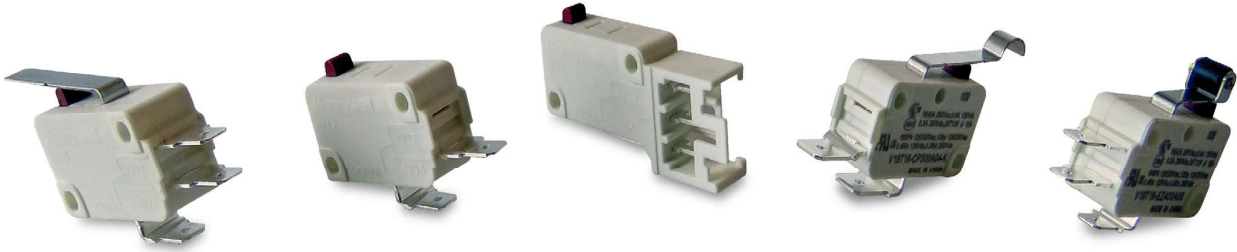

APPLICATIONS



Presence Detection

Ensures door latching and safe operation



Float Switch

On/off power to stop overflow conditions



Flow Switch

Enables safe and efficient water usage



Power Switch

Reliable system control for motors, pumps, fans



Operator Controls

Interface control for system auxiliary functions

VALUE PROPOSITION

The V19, Honeywell's unsealed MICRO SWITCH family provides a cost-conscious switch solution to assist in hitting overall system-level cost and design goals in high volume applications. The V19 switch provides a fully certified, reliable, and repeatable solution over the lifetime of the product. RAST 2.5, 5, and 7 termination styles available for automated manufacturing requirements (white goods).

V19 FEATURES	V19 BENEFITS	OUR VALUE
5 A & 16 A	Electrical ratings for design flexibility in one industry standard package size	Competitive cross references available
> 1M mechanical operations	Globally certified for reliable, repeatable actuation for life	Snap-spring mechanism with more than 80 years of MICRO SWITCH service
UL/CSA, cUL, ENEC, CQC	Identical system designs for platform applications worldwide	Certifications enable global design acceptance and cost savings in agency approvals
Cadmium-free contacts	RoHS 3, REACH and CalProp 65 compliant	
RAST 2.5 termination and housing	Enables IDT termination for automated machinery builds on signal-level and control circuits	Combined terminal and housing construction enables agency certification (UL94V-0 & IEC 60335-1) and material cost savings

Honeywell

MICRO SWITCH, V19 SERIES

Unless otherwise stated, all characteristic measurements tested according to UL, EN, and IEC standards and conditions. Parameters and acceptance criteria validated and confirmed in a certified lab environment. Technical details available upon request.

TABLE 1. PERFORMANCE SPECIFICATIONS	
CHARACTERISTIC	MEASURE
Circuitry	SPDT, SPNO, SPNC
Operating force	0,15 N to 3,92 N [15 g to 400 g]
Termination	quick connect; 6,35 mm x 0,80 mm [0.250 in x 0.032 in] quick connect 4,80 mm x 0,50 mm [0.187 in x 0.020 in] RAST-5 250#; RAST-7 250#; RAST-2.5 straight PCB
Actuators	pin plunger, integral lever options
Agency certification	ENEC, CQC, UL, cUL
Operating temperature (manufacturer specified)	code S: -25°C to 85°C [-13°F to 185°F] code T: -25°C to 125°C [-13°F to 257°F]
Humidity	validated to 240 hours at 40°C [40°F], 95 %RH
Mechanical life (cycles)	1 million cycles @ 60 cycles/minute max.
Ingress protection rating	IP40 per IEC 60529
Vibration resistance	10 Hz to 55 Hz, displacement 1,5 mm (peak-to-peak); no contact separation > 1 millisecond
Shock resistance	destruction: 500 m/s ² (50 g max.); switch is functional after test malfunction: 100 m/s ² (10 g max.); no contact separation > 1 millisecond
Switch resistance	50 mΩ max. for operating force >50; 100 mΩ max. for operating force ≤50
Dielectric strength	1000 Vac (RMS) for 1 minute; leakage current ≤0.5 mA between open contacts 1500 Vac (RMS) for 1 minute; leakage current ≤0.5 mA between live parts and ground
Insulation resistance	min. 100 mΩ (500 Vdc for one minute)
Contact material	cadmium-free silver alloy
Housing material	PBT thermoplastic polyester
Actuating button material	phenolic
Auxiliary actuator material	stainless steel
Common terminal material	brass
NO/NC terminal material	brass
Moving blade	silver-plated brass
Operating speed	0,3 mm/s to 1000 mm/s (pin plunger)
Operating frequency	60 CPM mechanical, 25 CPM electrical
Average unit weight	7.17g
Packaging dimensions/weight	505 mm x 310 mm x 225 mm/1900 g

MICRO SWITCH, V19 SERIES

TABLE 2. ELECTRICAL SPECIFICATIONS		
RATING/NOMENCLATURE CODE	UL/CUL (CUL 61058-1, FILE 12252) AMERICAS	ENEC (IEC 61058-1) EUROPE CQC (GB15092-1) ASIA-PACIFIC
05	5 GPA 125/250 Vac; 6 GPA 125/250 Vac 1/10 HP 125/250 Vac 0.4 RA 125 Vdc; 0.3 RA 250 Vdc 10,000 cycles	5 (2.5) A 125/250 Vac, 6 (2.5) A 125/250 Vac 0.4 A 125 Vdc, 0.3 A 250 Vdc 10,000 cycles
16	16 GPA 125/250 Vac 1/2 HP 125/250 Vac 0.6 RA 125 Vdc; 0.3 RA 250 Vdc 10,000 cycles	16 (4) A 250 Vac 0.6 A 125 Vdc; 0.3 A 250 Vdc 10,000 cycles

- RA = Resistive Amps (Resistive Load)
- GPA = General Purpose Amps (Inductive Load, 75 % to 80 % power factor)
- VL = Lamp Load
- XX (Y) = XX max. resistive value (Amps) and (Y) max. inductive value (Amps)

FIGURE 1. PRODUCT NOMENCLATURE

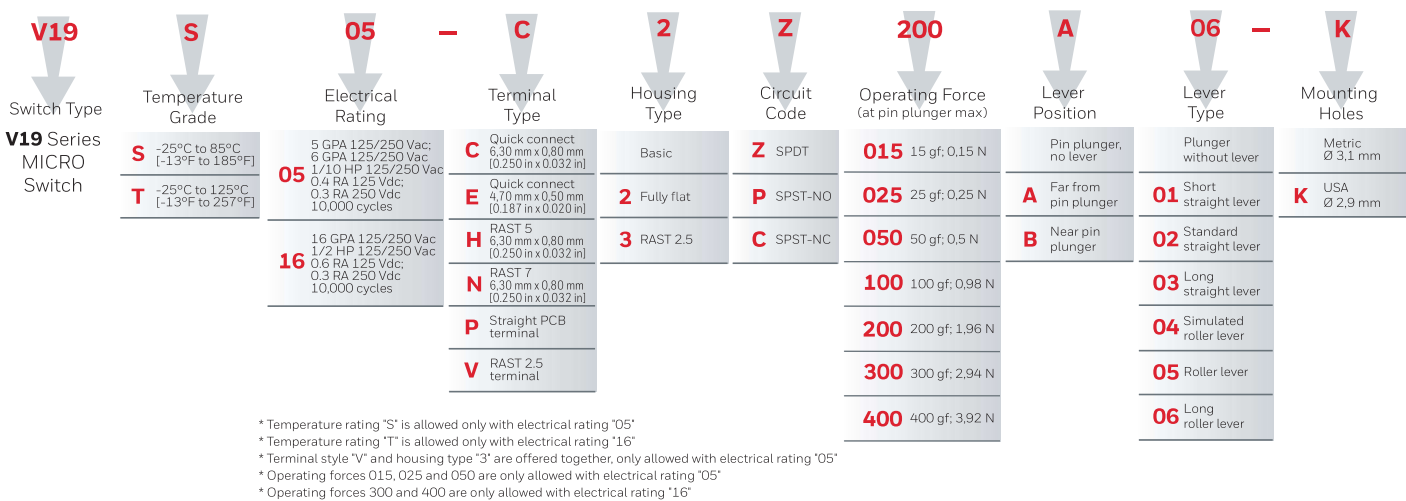









FIGURE 2. LOAD LIFE CURVE

add load life curve as a figure.

- Current rating of a switch at a given voltage represents the maximum electrical load the switch is designed to control
- Based on connection of the circuit to either the normally open or normally closed throw of the switch
- Assumes the plunger of the switch is driven to full over travel and full release actuation







MICRO SWITCH, V19 SERIES

TABLE 3. CONFIGURATIONS

ELECTRICAL RATING	LEVER POSITION	ACTUATION TYPE	ACTUATION PICTURE	OPERATING FORCE CODE	MAX OPERATING FORCE (g)	MIN RELEASE FORCE (g)	OP (mm)	PT MAX. (mm)	DT MAX. (mm)	OT MIN. (mm)
5 A	A	Pin plunger		015	15	4	14,7 ±0,4	1,2	0,4	1,0
				025	25	5				
				050	50	8				
				100	100	15				
				200	200	50				
		Short straight lever		015	15	4	15,2 ±0,5	1,6	1,2	0,8
				025	25	5				
				050	50	8				
				100	100	15				
				200	200	50				
		Standard straight lever		015	10	2	15,2 ±1,2	4,0	2,0	1,6
				025	15	3				
				050	30	4				
				100	50	10				
				200	125	14.3				
		Long straight lever		015	5	2	15,2 ±2,6	9,0	3,8	2,0
				025	10	2				
				050	15	3				
				100	25	4				
				200	70	6				
		Simulated roller lever		015	10	2	18,7 ±1,2	4,0	3,5	1,6
				025	15	3				
				050	30	4				
				100	50	10				
				200	125	14.3				
		Roller lever		015	15	4	20,7 ±0,6	1,6	0,9	0,8
				025	25	8				
				050	60	8				
				100	140	15				
				200	240	50				
		Long roller lever		015	10	2	20,7 ±1,2	4,0	2,7	1,6
				025	15	2				
				050	30	4				
				100	50	10				
				200	125	14.3				







MICRO SWITCH, V19 SERIES

TABLE 3. CONFIGURATIONS

ELECTRICAL RATING	LEVER POSITION	ACTUATION TYPE	ACTUATION PICTURE	OPERATING FORCE CODE	MAX OPERATING FORCE (g)	MIN RELEASE FORCE (g)	OP (mm)	PT MAX. (mm)	DT MAX. (mm)	OT MIN. (mm)
5 A	B	Pin plunger		015	15	2	14,7 ±0,4	1,2	0,4	1,0
				025	25	5				
				050	60	8				
				100	100	15				
				200	200	50				
		Short straight lever		015	10	2	15,3 ± 0,8	2,0	1,2	1,1
				025	15	3				
				050	35	5				
				100	65	8				
				200	130	16				
		Standard straight lever		015	5	2	15,3 ± 2,5	6,0	2,0	2,5
				025	10	2				
				050	20	3				
				100	35	4				
				200	70	8				
		Long straight lever		015	2	2	15,3 ± 4,5	9,0	3,8	4,0
				025	5	2				
				050	10	2				
				100	20	2				
				200	35	4				
		Simulated roller lever		015	5	2	18,5 ± 2,5	6,0	3,5	2,0
				025	10	2				
				050	20	3				
				100	40	3				
				200	75	10				
		Roller lever		015	10	2	21,0 ±1,0	2,0	0,9	1,0
				025	15	3				
				050	35	3				
100	80			8						
200	160			15						
Long roller lever		015	5	2	21,4 ±1,2	6,0	2,7	2,0		
		025	2	10						
		050	20	5						
		100	40	3						
		200	75	10						







MICRO SWITCH, V19 SERIES

TABLE 3. CONFIGURATIONS

ELECTRICAL RATING	LEVER POSITION	ACTUATION TYPE	ACTUATION PICTURE	OPERATING FORCE CODE	MAX OPERATING FORCE (g)	MIN RELEASE FORCE (g)	OP (mm)	PT MAX. (mm)	DT MAX. (mm)	OT MIN. (mm)
16 A	A	Pin plunger		100	100	15	14,7 ±0,4	1,2	0,4	1,0
				200	200	50				
				300	300	75				
				400	400	79				
		Short straight lever		100	100	15	15,2 ±0,5	1,6	1,2	0,8
				200	200	50				
				300	300	75				
				400	400	50				
		Standard straight lever		100	50	10	15,2 ±1,2	4,0	2,0	1,6
				200	125	14.3				
				300	150	40				
				400	250	25.5				
		Long straight lever		100	25	4	15,2 ±2,6	9,0	3,8	2,0
				200	70	6				
				300	100	15				
				400	130	12.2				
		Simulated roller lever		100	50	10	18,7 ±1,2	4,0	3,5	1,6
				200	125	14.3				
				300	150	40				
				400	250	25.5				
		Roller lever		100	140	15	20,7 ±0,6	1,6	0,9	0,8
				200	240	50				
				300	340	50				
				400	480	50				
		Long roller lever		100	50	10	20,7 ±1,2	4,0	2,7	1,6
				200	125	14.3				
				300	150	40				
				400	250	25.5				

MICRO SWITCH, V19 SERIES

TABLE 3. CONFIGURATIONS

ELECTRICAL RATING	LEVER POSITION	ACTUATION TYPE	ACTUATION PICTURE	OPERATING FORCE CODE	MAX OPERATING FORCE (g)	MIN RELEASE FORCE (g)	OP (mm)	PT MAX. (mm)	DT MAX. (mm)	OT MIN. (mm)
16 A	B	Pin plunger		100	100	15	14,7 ±0,4	1,2	0,4	1,0
				200	200	50				
				300	300	75				
				400	400	150				
		Short straight lever		100	65	8	15,3 ± 0,8	2,0	1,2	1,1
				200	130	16				
				300	150	45				
				400	300	75				
		Standard straight lever		100	35	4	15,3 ± 2,5	6,0	2,0	2,5
				200	70	8				
				300	75	25				
				400	130	40				
		Long straight lever		100	20	2	15,3 ± 4,5	9,0	3,8	4,0
				200	35	4				
				300	40	10				
				400	80	25				
		Simulated roller lever		100	40	3	18,5 ± 2,5	6,0	3,5	2,0
				200	75	10				
				300	80	20				
				400	150	50				
		Roller lever		100	80	8	21,0 ±1,0	2,0	0,9	1,0
				200	160	15				
				300	200	40				
				400	350	100				
		Long roller lever		100	40	3	21,4 ±1,2	6,0	2,7	2,0
				200	75	10				
				300	100	30				
				400	150	50				

MICRO SWITCH, V19 SERIES

MOUNTING DIMENSIONS

FIGURE 3. V19 SERIES STANDARD SWITCH DIMENSIONS

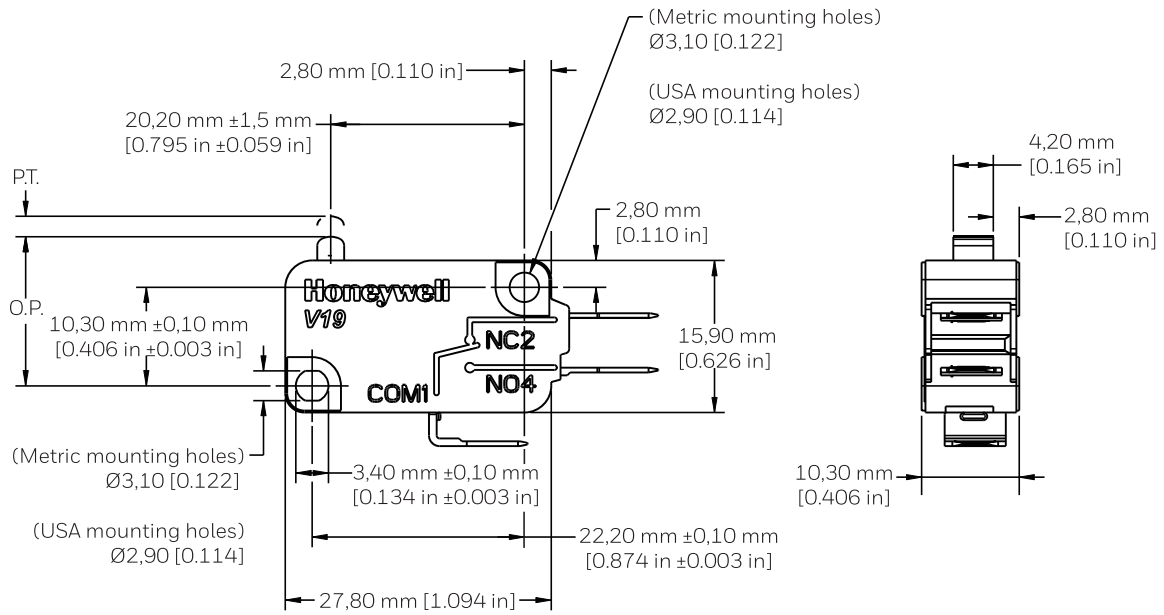

FIGURE 4. V19 SERIES HOUSING DIMENSIONS

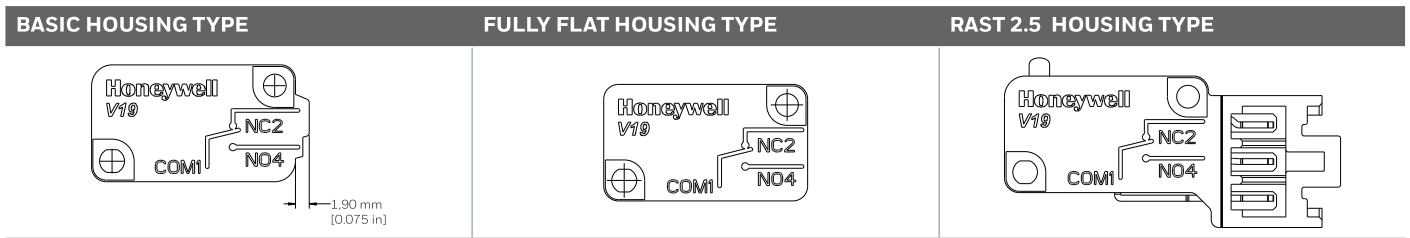
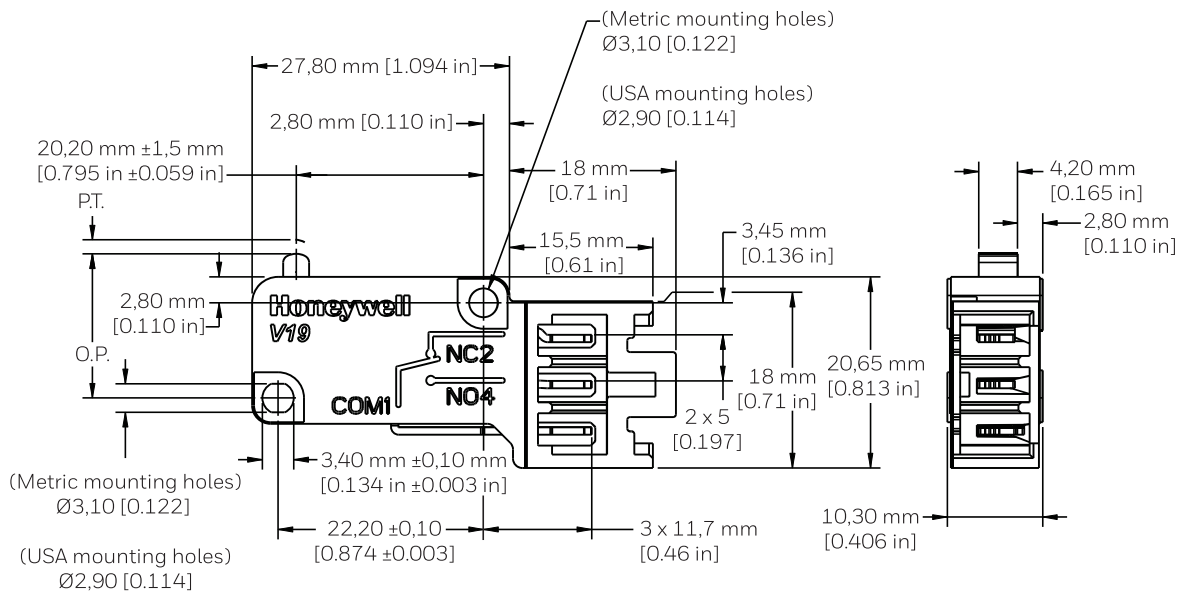

FIGURE 5. V19 SERIES RAST 2.5 SWITCH DIMENSIONS



MICRO SWITCH, V19 SERIES

CONNECTION DIMENSIONS

**FIGURE 6. V19 SERIES C-STYLE QUICK CONNECT •
6,35 MM WIDE X 0,8 MM THICK [0.25 IN WIDE X 0.031 IN THICK]**

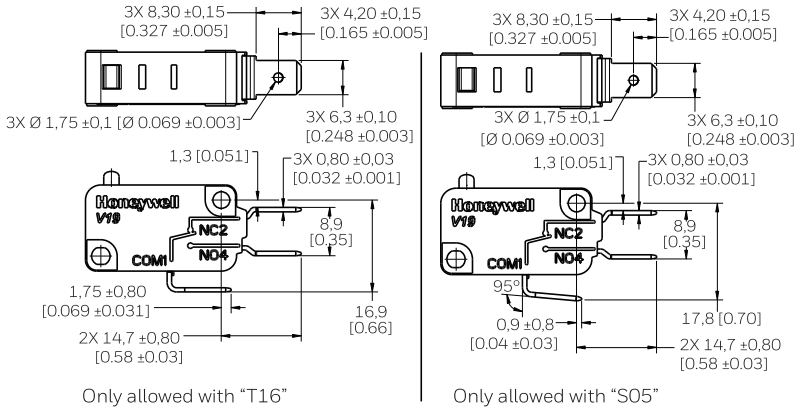

**FIGURE 7. V19 SERIES H-STYLE RAST-5 250#
CONNECTOR**

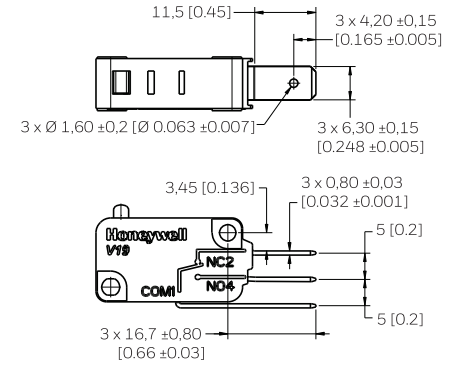

**FIGURE 8. V19 SERIES E-STYLE QUICK CONNECT •
4,80 MM WIDE X 0,5 MM THICK [0.189 IN WIDE X 0.020 IN THICK]**

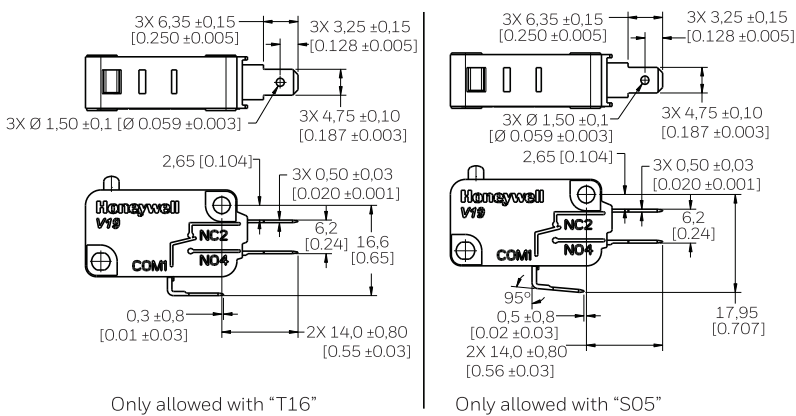

**FIGURE 9. V19 SERIES N-STYLE RAST-7 250#
CONNECTOR**

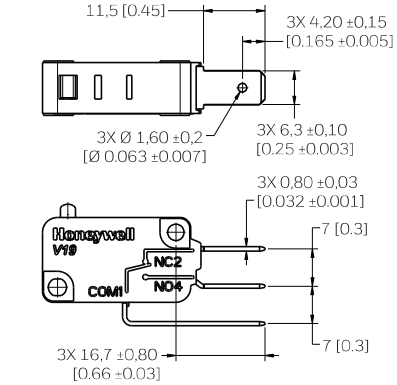
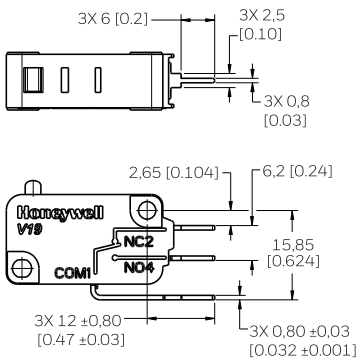

FIGURE 10. V19 SERIES P-STYLE STRAIGHT PCB TERMINAL



MICRO SWITCH, V19 SERIES

STANDARD LEVER OPTIONS • DIMENSIONS

FIGURE 11. V19 SERIES A01/STRAIGHT SHORT LEVER

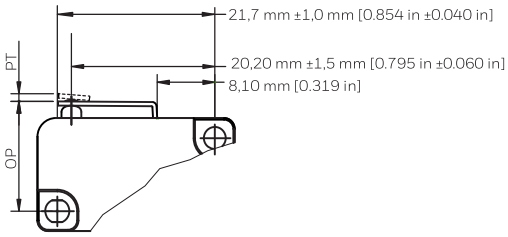

FIGURE 12. V19 SERIES A02/STANDARD STRAIGHT LEVER

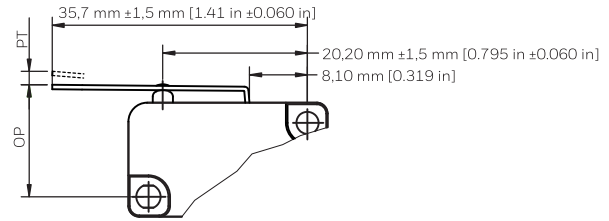

FIGURE 13. V19 SERIES A03/LONG STRAIGHT LEVER

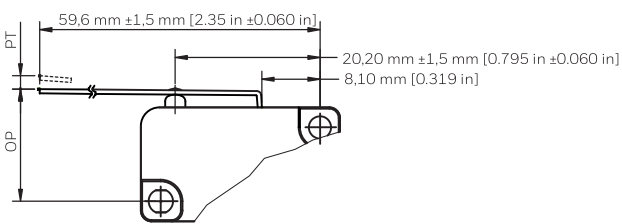

FIGURE 14. V19 SERIES A04/SIMULATED ROLLER LEVER

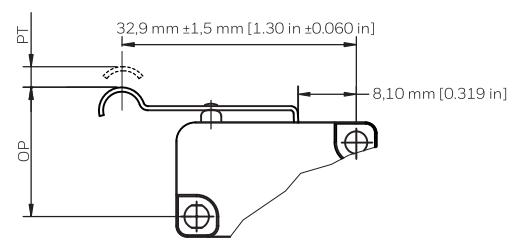

FIGURE 15. V19 SERIES A05/SHORT ROLLER LEVER

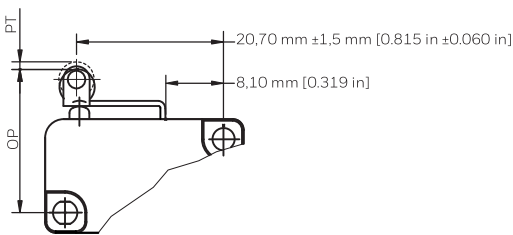
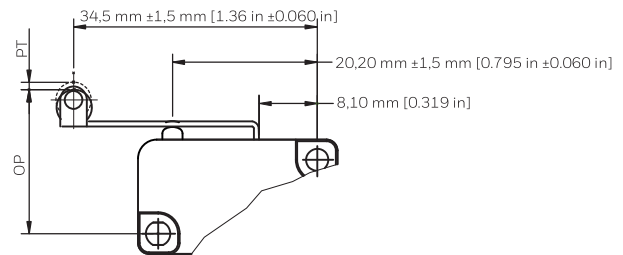
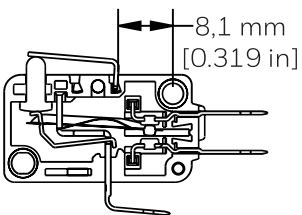

FIGURE 16. V19 SERIES A06/ROLLER LEVER



NOTE: These dimensions apply for the "A" lever position. For the "B" lever position, please add 5,8 mm [0.224 in].

Position A



Position B

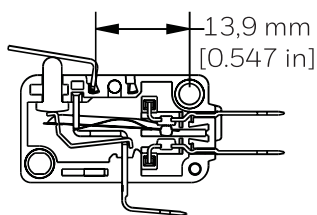

MICRO SWITCH, V19 SERIES



TABLE 4. V19 MOUNTING CHARACTERISTICS: LEVER POSITION A

		OPERATE FORCE CODE							OP (mm)	PT MAX. (mm)	DT MAX. (mm)	OT MIN. (mm)
		015	025	050	100	200	300	400				
MAXIMUM OPERATE FORCE (GRAMS)												
	Pin plunger	15	25	50	100	200	300	400	14,7 ±0,4	1,2	0,4	1,0
01	Short straight lever	15	25	50	100	200	300	400	15,2 ±0,5	1,6	1,2	0,8
02	Standard straight lever	10	15	30	50	125	150	250	15,2 ±1,2	4,0	2,0	1,6
03	Long straight lever	5	10	15	25	70	100	130	15,2 ±2,6	9,0	3,8	2,0
04	Simulated roller lever	10	15	30	50	125	150	250	18,7 ±1,2	4,0	3,5	1,6
05	Roller lever	15	25	60	140	240	340	480	20,7 ±0,6	1,6	0,9	0,8
06	Long roller lever	10	15	30	50	125	150	250	20,7 ±1,2	4,0	2,7	1,6
MINIMUM RELEASE FORCE (GRAMS)												
	Pin plunger	4	5	8	15	50	75	79				
01	Short straight lever	4	5	8	15	50	75	50				
02	Standard straight lever	2	3	4	10	14,3	40	25,5				
03	Long straight lever	2	2	3	4	6	15	12,2				
04	Simulated roller lever	2	3	4	10	14,3	40	25,5				
05	Roller lever	4	8	8	15	50	50	50				
06	Long roller lever	2	2	4	10	14,3	40	25,5				

TABLE 5. V19 MOUNTING CHARACTERISTICS: LEVER POSITION B

		OPERATE FORCE CODE							OP (mm)	PT MAX. (mm)	DT MAX. (mm)	OT MIN. (mm)
		015	025	050	100	200	300	400				
MAXIMUM OPERATE FORCE (GRAMS)												
	Pin plunger	15	25	50	100	200	300	400	14,7 ±0,4	1,2	0,4	1,0
01	Short straight lever	10	15	35	65	130	150	300	15,3 ±0,8	2,0	1,2	1,1
02	Standard straight lever	5	10	20	35	70	75	130	15,3 ±2,5	6,0	2,0	2,5
03	Long straight lever	2	5	10	20	35	40	80	15,3 ±4,5	9,0	3,8	4,0
04	Simulated roller lever	5	10	20	40	75	80	150	18,5 ±2,5	6,0	3,5	2,0
05	Roller lever	10	15	35	80	160	200	350	21,0 ±1,0	2,0	0,9	1,0
06	Long roller lever	5	2	20	40	75	100	150	21,4 ±1,2	6,0	2,7	2,0
MINIMUM RELEASE FORCE (GRAMS)												
	Pin plunger	2	5	8	15	50	75	150				
01	Short straight lever	2	3	5	8	16	45	75				
02	Standard straight lever	2	2	3	4	8	25	40				
03	Long straight lever	2	2	2	2	4	10	25				
04	Simulated roller lever	2	2	3	3	10	20	50				
05	Roller lever	2	3	3	8	15	40	100				
06	Long roller lever	2	10	5	3	10	30	50				

HONEYWELL UNSEALED V BASIC PORTFOLIO

	V7	V15	V19
			
Target Market	Applications requiring precision, long term reliability, and design flexibility in electrical ratings	Cost sensitive applications requiring configurability in actuation, termination, and operating characteristics	Applications in major and small appliances or designs that require simple configurations
Differentiator	Wide range of max operating force and precise differential travel specs key for a more accurate switch actuation	Industry standard switch footprint and global certifications ideal for “low-cost-of-failure” applications	Provides balance between cost and performance in high-volume switch applications
Options	MIL-PRF-8805 listings available V3 family designed for rugged applications where reliability and repeatability is key	Multiple Contact Material Options Contact variants to enable design and regulation compliance	RAST Termination Multiple RAST standard terminal options for optimizing automated manufacturing processes

RELATED DOCUMENTATION

- V Basics Range Guide
- Applying Precision Switches
- V7 Datasheet
- V15 Datasheet

FOR MORE INFORMATION

Honeywell Sensing and Internet of Things services its customers through a worldwide network of sales offices and distributors. For application assistance, current specifications, pricing, or the nearest Authorized Distributor, visit sensing.honeywell.com or call:

USA/Canada	+302 613 4491
Latin America	+1 305 805 8188
Europe	+44 1344 238258
Japan	+81 (0) 3-6730-7152
Singapore	+65 6355 2828
Greater China	+86 4006396841

Honeywell Sensing and Internet of Things

830 East Arapaho Road
Richardson, TX 75081
sensing.honeywell.com

WARRANTY/REMEDY

Honeywell warrants goods of its manufacture as being free of defective materials and faulty workmanship during the applicable warranty period. Honeywell’s standard product warranty applies unless agreed to otherwise by Honeywell in writing; please refer to your order acknowledgment or consult your local sales office for specific warranty details. If warranted goods are returned to Honeywell during the period of coverage, Honeywell will repair or replace, at its option, without charge those items that Honeywell, in its sole discretion, finds defective. **The foregoing is buyer’s sole remedy and is in lieu of all other warranties, expressed or implied, including those of merchantability and fitness for a particular purpose. In no event shall Honeywell be liable for consequential, special, or indirect damages.**

While Honeywell may provide application assistance personally, through our literature and the Honeywell web site, it is buyer’s sole responsibility to determine the suitability of the product in the application.

Specifications may change without notice. The information we supply is believed to be accurate and reliable as of this writing. However, Honeywell assumes no responsibility for its use.

⚠ WARNING **IMPROPER INSTALLATION**

- Consult with local safety agencies and their requirements when designing a machine-control link, interface and all control elements that affect safety.
- Strictly adhere to all installation instructions.

Failure to comply with these instructions could result in death or serious injury.

⚠ WARNING **MISUSE OF DOCUMENTATION**

- The information presented in this product sheet is for reference only. Do not use this document as a product installation guide.
- Complete installation, operation, and maintenance information is provided in the instructions supplied with each product.

Failure to comply with these instructions could result in death or serious injury.