

**YS16VE SERIES**



Input: 85-265VAC 50/60Hz  
 Output Voltage: 5V-36V DC  
 Rated Power: 18W max

**Features**

- Univeral AC input/ Full range
- Energy efficiency level VI
- Leakage Current: < 0.25mA
- Extremely low leakage current
- Protection: Over load/Over voltage/Short circuit
- Withstand voltage : 3KV
- Life Warranty: 3 years

**Application**

- Digital equipment
- Consumer electronic devices
- Telecommunication devices
- Office facilities
- Industrial equipments



**■ Dimensions and Installation**

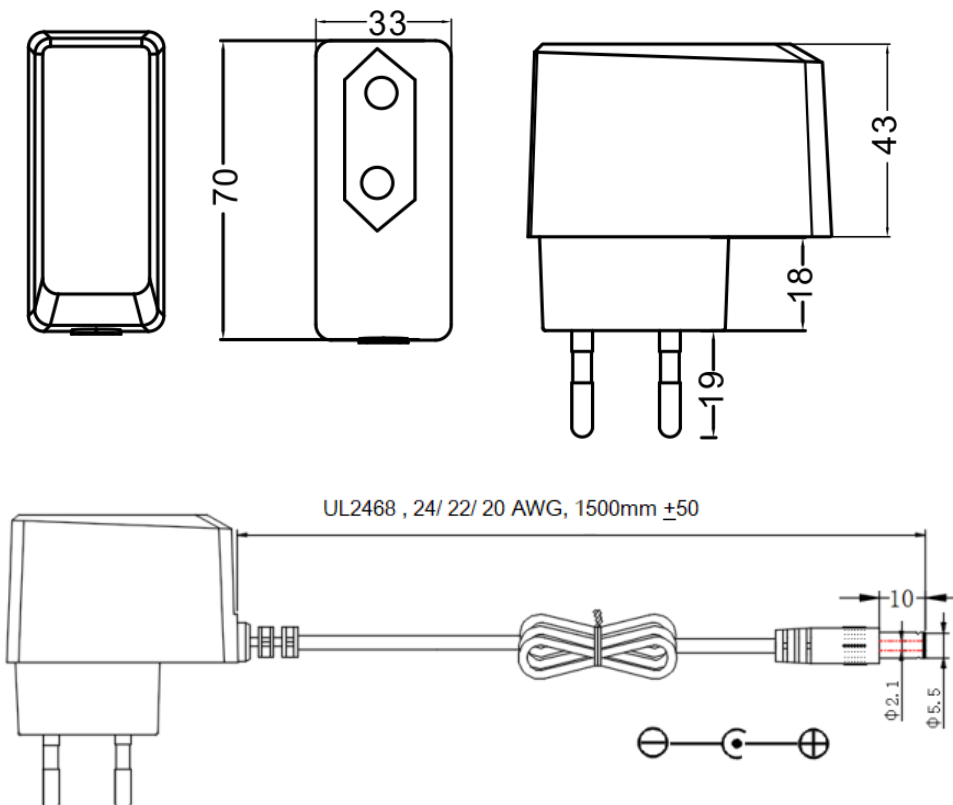

## YS16V-E SERIES

MODEL DETAIL SPEC.		YS16V-0503000	YS16V-0902000	YS16V-1201500	YS16V-1501200	YS16V-2400750	YS16V-3600500
INPUT	Input Voltage range:	85-265VAC					
	Input Frequency:	50/60Hz					
	Inrush Current:	50A/230VAC					
	AC Current:	0.4A/230VAC					
	Leakage Current:	< 0.25mA/240VAC					
	Efficiency:	81%	85%	86%	87%	87%	88%
OUTPUT	DC Voltage:	5V	9V	12V	15V	24V	36V
	Rated Current:	3A	2A	1.5A	1.2A	0.75A	0.5A
	Rated Power:	15W	18W	18W	18W	18W	18W
	Voltage Tolerance:	±5.0%	±5.0%	±5.0%	±5.0%	±5.0%	±5.0%
	Ripple and Noise:	75mVp-p	90mVp-p	120mVp-p	150mVp-p	240mVp-p	300mVp-p
	Line Regulation:	±3%					
	Load Regulation:	±5%	±5%	±5%	±5%	±5%	±5%
	Setup, Rise, Hold Up time:	3000ms, 60ms/10ms 230VAC at full load					
ENVIRONMENTAL	Operating Temperature:	-20 ~ +60 (Refer to "Derating Curve")					
	Storage Temp:	-40°C ~ 85°C					
	Storage Humidity:	10 ~ 95% RH					
	Working Humidity:	20 ~ 95% RH non-condensing					
PROTECTION	Over Load:	105% -150% rated output power					
		Protection type: Hiccup mode, recovers automatically after fault condition is removed					
	Over Voltage:	105% -130% rated output power					
		Protection type: Shut down o/p voltage, re-power on to recover					
Short Circuit :	Shut down o/p voltage, re-power on to recover						
SAFETY & EMC	Safety Regulations:	TUV , EN62368-1					
	Withstand Voltage:	I/P-O/P:3KVAC I/P-FG:2KVAC O/P-FG:0.5KVAC					
	Isolation Resistance:	I/P-O/P, I/P-FG, O/P-FG:100M Ohms / 500VDC / 25°C/ 70% RH					
	EMC Emission:	EN55032 (CISPR32), Class B, EN61000-3-2,-3,					
	EMC Immunity:	EN/EN61000-4-2,3,4,5,6,8,11					
OTHER	MTBF:	500Khrs min. MIL-HDBK-217F(25°C)					
	Size:	70*33*80mm					
	Weight:	120g / pcs					
	Packaging:	100PCS/CTN					

**YS16V-E SERIES**

**Deduction curve and temperature**

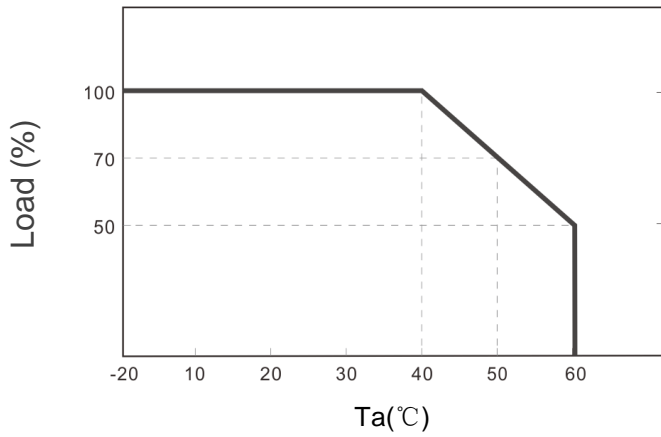

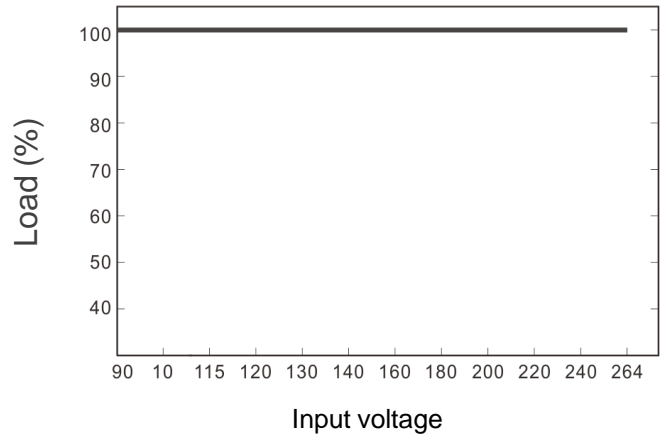

**Minus output and input voltage curves**







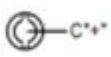

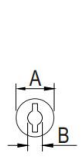
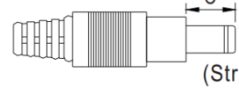
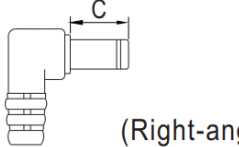

**DC output plug**

Standard plug: D1M

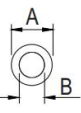
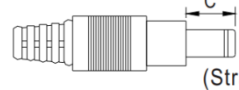
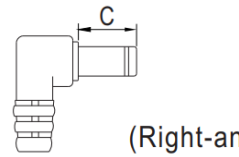
D1M	Pin Assignment
 	 <p>Outside ⊖ ⊕ Inside</p> <p>-V not connected to AC FG(standard) -V connected to AC FG(optional)</p>

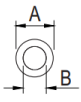
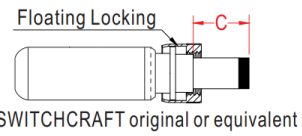

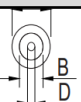
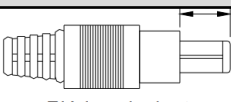
## YS16V-E SERIES

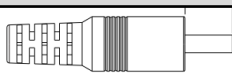
Optional DC plug: (Available in customized cable or quick adapter)

Tuning Fork Style		Type No.	A	B	C	Quick Adapter Accessory	
			OD	ID	L		
   	D1I	5.5	2.1	9.5	Available (Current rating: 7.5A max.)		
	D1L	5.5	2.5	9.5			
	D1M	5.5	2.1	11.0			
	D1IR	5.5	2.5	9.5			
	D1JR	5.5	2.1	11.0			
	D1LR	5.5	2.5	9.5			
	D1MR	5.5	2.5	11.0			
Barrel Style		Type No.	A	B	C	Quick Adapter Accessory	
			OD	ID	L		
   	D2I	5.5	2.1	9.5	None		
	D2J	5.5	2.1	11.0			
	D2L	5.5	2.5	9.5			
	D2M	5.5	2.1	11.0			
	D2IR	5.5	2.5	9.5			
	D2JR	5.5	2.1	11.0			
	D2LR	5.5	2.5	9.5			
D2MR	5.5	2.5	11.0				
Lock Style		Type No.	A	B	C	Quick Adapter Accessory	
			OD	ID	L		
   Floating Locking SWITCHCRAFT original or equivalent	D2S(S761K)	5.53	2.03	12.06	None		
	D2K(761K)	5.53	2.54	12.06			
	D2C(S760K)	5.53	2.03	9.52			
	D2D(760K)	5.53	2.54	9.52			
Center Pin Style		Type No.	A	B	C	D	Quick Adapter Accessory
			OD	ID	L	Center Pin	
   EIAJ equivalent	D4A	5.5	3.4	11.0	1.0	Available (Current rating: 7.5A max.)	
	D4B	6.5	4.4	11.0	1.4		
	D4C	7.4	5.1	11.0	0.6		
Min. Pin Style		Type No.	A	B	C	Quick Adapter Accessory	
			OD	ID	L		
   EIAJ equivalent	D3A	2.35	0.7	11.0	Available (Current rating: 5A max.)		
	D3B	4.0	1.7	11.0			
	D3C	4.75	1.7	11.0			

## YS16V-E SERIES

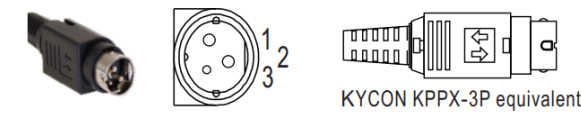
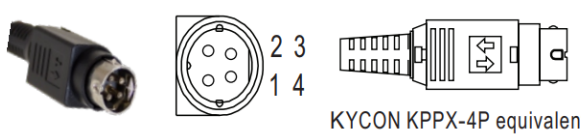
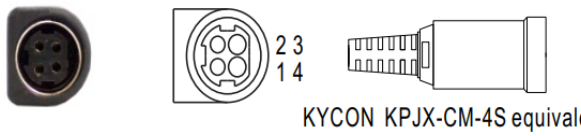
Optional DC plug: (Available in customized cable or quick adapter)

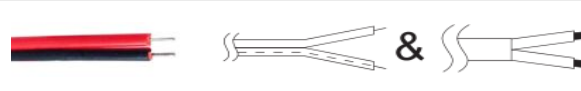
Min.Din 3Pin with Lock (male)	Type No.	Pin Assignment		Quick Adapter Accessory
		PIN No.	Output	
 <p>KYCON KPPX-3P equivalent</p>	M6B	1	+Vo	Available (Current rating: 7.5A max.)
		2	-Vo	
		3	+Vo	
Min.Din 4Pin with Lock (male)	Type No.	Pin Assignment		Available (Current rating: 7.5A max.)
 <p>KYCON KPPX-4P equivalent</p>	M7B	PIN No.	Output	
		1	+Vo	
		2	-Vo	
		3	-Vo	
		4	+Vo	
Min.Din 4Pin with Lock (female)	Type No.	Pin Assignment		None
 <p>KYCON KPJX-CM-4S equivalent</p>	M7BF	PIN No.	Output	
		1	+Vo	
		2	-Vo	
		3	-Vo	
		4	+Vo	
DIN 5Pin (male)	Type No.	Pin Assignment		Available (Current rating: 7.5A max.)
	M1B	PIN No.	Output	
		1	-Vo	
		2	-Vo	
		3	+Vo	
		4	-Vo	
		5	+Vo	
Stripped and tinned leads	Type No.	Pin Assignment		None
	by customer	1	+Vo	
		2	-Vo	