

# DC/DC Converter

## VRB\_LD-15WR3 Series

# MORNSUN®

15W isolated DC-DC converter,  
Wide input and regulated single output



UL US CE CB Patent Protection RoHS

## FEATURES

- Wide 2:1 input voltage range
- High efficiency up to 90%
- No-load power consumption as low as 0.12W
- I/O Isolation test voltage 1.5K VDC
- Input under-voltage protection, output short-circuit, over-current, over-voltage protection
- Operating ambient temperature range: -40°C to +85°C
- Meets CISPR32/EN55032 CLASS A, without extra components
- Six-sided metal shielding package
- IEC60950/UL60950/EN60950 approved

VRB\_LD-15WR3 series of isolated 15W DC-DC products with a 2:1 input voltage range. They feature efficiencies of up to 90%, 1500VDC input to output isolation, operating ambient temperature range of -40°C ~ +85°C, input under-voltage protection, output short-circuit, over-voltage, over-current protection. They meet CLASS A of CISPR32/EN55032 EMI standards without external components, and they are widely used in applications such as data transmission device, battery power supplies, tele-communication device, distributed power supply system, hybrid module system, remote control system, industrial robot system fields.

## Selection Guide

Certification	Part No. ①	Input Voltage (VDC)		Output		Full Load Efficiency® (%) Min./Typ.	Max. Capacitive Load(μF)
		Nominal (Range)	Max. ②	Voltage (VDC)	Current (mA) Max./Min.		
UL/CE/CB	VRB2405LD-15WR3	24 (18-36)	40	5	3000/0	87/89	4700
	VRB2412LD-15WR3			12	1250/0	87/89	1000
	VRB2415LD-15WR3			15	1000/0	87/89	820
	VRB2424LD-15WR3			24	625/0	88/90	270
--	VRB4803LD-15WR3	48 (36-75)	80	3.3	4000/0	81/83	4700
UL/CE/CB	VRB4805LD-15WR3			5	3000/0	86/88	4700
	VRB4812LD-15WR3			12	1250/0	86/88	1000
	VRB4815LD-15WR3			15	1000/0	87/89	820
	VRB4824LD-15WR3			24	625/0	87/89	270

Notes: ①Use "H" suffix for heat sink mounting. We recommend to choose modules with a heat sink for enhanced heat dissipation and applications with extreme temperature requirements;  
②Exceeding the maximum input voltage may cause permanent damage;  
③Efficiency is measured at nominal input voltage and rated output load.

## Input Specifications

Item	Operating Conditions	Min.	Typ.	Max.	Unit
Input Current (full load / no-load)	24VDC input	5V output	--	702/30	718/75
		Others	--	702/5	718/10
	48VDC input	3.3V/5V output	--	355/20	363/30
		Others	--	351/5	363/10
Reflected Ripple Current	24VDC input	--	30	--	mA
	48VDC input	--	30	--	
Surge Voltage (1sec. max.)	24VDC input	-0.7	--	50	VDC
	48VDC input	-0.7	--	100	VDC
Start-up Voltage	24VDC input	--	--	18	VDC
	48VDC input	--	--	36	
Under-voltage protection	24VDC input	12	15.5	--	VDC
	48VDC input	26	30	--	

MORNSUN®

MORNSUN GUANGZHOU SCIENCE & TECHNOLOGY CO.,LTD.

2019.09.27-A/6

Page 1 of 6

MORNSUN Guangzhou Science & Technology Co., Ltd. reserves the copyright and right of final interpretation

Start-up Time	Nominal input voltage & constant resistance load	--	10	--	ms
Input Filter		Pi filter			
Ctrl *	Module on	Ctrl pin open or pulled high (3.5-12VDC)			
	Module off	Ctrl pin pulled low to GND (0-1.2VDC)			
	Input current when off	--	4	7	mA
Hot Plug		Unavailable			

Note: \*The Ctrl pin voltage is referenced to input GND.

### Output Specifications

Item	Operating Conditions	Min.	Typ.	Max.	Unit	
Voltage Accuracy	0% -100% load	--	±1	±3	%	
Linear Regulation	Input voltage variation from low to high at full load	--	±0.2	±0.5		
Load Regulation	Nominal input voltage	--	±0.5	±1		
Transient Recovery Time		--	300	500	μs	
Transient Response Deviation	25% load step change, Nominal input voltage	3.3V output	--	±5	±8	%
		Others	--	±3	±5	
Temperature Coefficient	Full load	--	--	±0.03	%/°C	
Ripple & Noise*	20MHz bandwidth, 5% -100% load	--	50	100	mVp-p	
Trim	Input voltage range	90	--	110	%Vo	
Over-voltage Protection		110	--	160		
Over-current Protection		110	--	190	%Io	
Short-circuit Protection		Hiccup, continuous, self-recovery				

Note: The "parallel cable" method is used for Ripple and Noise test, please refer to DC-DC Converter Application Notes for specific information.  
\*Ripple & Noise at ≤ 5% load is 5%Vo. Max.

### General Specifications

Item	Operating Conditions	Min.	Typ.	Max.	Unit	
Isolation	Input-output Electric Strength test for 1 minute with a leakage current of 1mA max.	1500	--	--	VDC	
Insulation Resistance	Input-output resistance at 500VDC	1000	--	--	MΩ	
Isolation Capacitance	Input-output capacitance at 100KHz/0.1V	VRB2424LD-15W(H)R3	--	2050	--	pF
		VRB4824LD-15W(H)R3	--	1050	--	
		Others	--	1050	--	
Operating Temperature	See Fig. 1	-40	--	+85	°C	
Storage Temperature		-55	--	+125		
Storage Humidity	Non-condensing	5	--	95	%RH	
Pin Soldering Resistance Temperature	Soldering spot is 1.5mm away from case for 10 seconds	--	--	300	°C	
Vibration		10-55Hz, 2G, 30 Min. along X, Y and Z				
Switching Frequency *	PWM mode	--	270	--	KHz	
MTBF	MIL-HDBK-217F@25°C	1000	--	--	K hours	

Note: \*Switching frequency is measured at full load. The module reduces the switching frequency for light load (below 50%) efficiency improvement.

### Mechanical Specifications

Case Material			Aluminum alloy
Dimensions	Horizontal package( without heat sink)		50.80 x 25.40 x 11.80 mm
	Horizontal package( with heat sink)		51.40 x 26.20 x 16.50 mm
Weight	without heat sink	Horizontal package	26.0g(Typ.)
	with heat sink	Horizontal package	34.0g(Typ.)
Cooling Method			Free air convection

Electromagnetic Compatibility (EMC)

Emissions	CE	Others	CISPR32/EN55032	CLASS A (without external components)/ CLASS B (see Fig.3-② for recommended circuit)	
		3.3V output	CISPR32/EN55032	CLASS B (see Fig.3-② for recommended circuit)	
	RE	Others	CISPR32/EN55032	CLASS A (without external components)/ CLASS B (see Fig.3-② for recommended circuit)	
		3.3V output	CISPR32/EN55032	CLASS B (see Fig.3-② for recommended circuit)	
Immunity	ESD		IEC/EN61000-4-2	Contact ±4KV	perf. Criteria B
	RS		IEC/EN61000-4-3	10V/m	perf. Criteria A
	EFT		IEC/EN61000-4-4	±2KV (see Fig.3-① for recommended circuit)	perf. Criteria B
	Surge		IEC/EN61000-4-5	line to line ±2KV (see Fig.3-① for recommended circuit)	perf. Criteria B
	CS		IEC/EN61000-4-6	3 Vr.m.s	perf. Criteria A
	Voltage dips, short interruptions and voltage variations immunity		IEC/EN61000-4-29	0%, 70%	perf. Criteria B

Typical Characteristic Curves

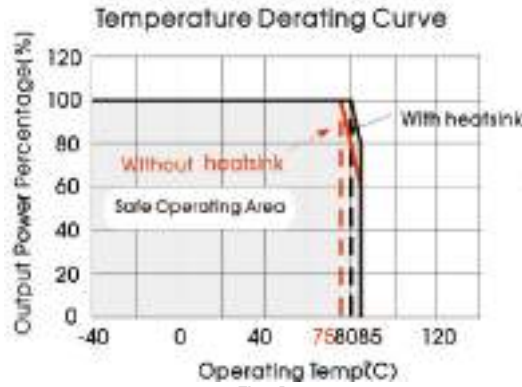
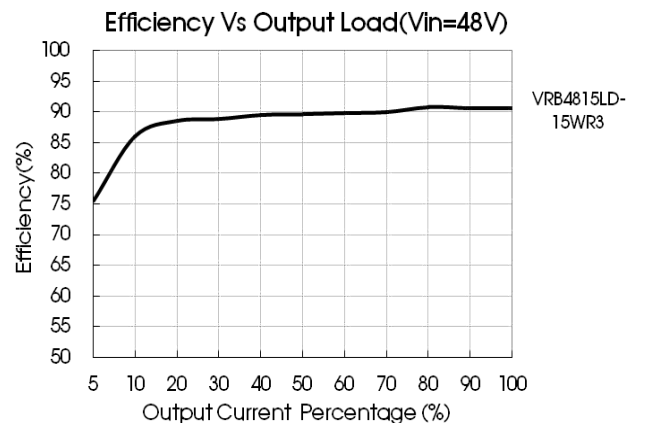
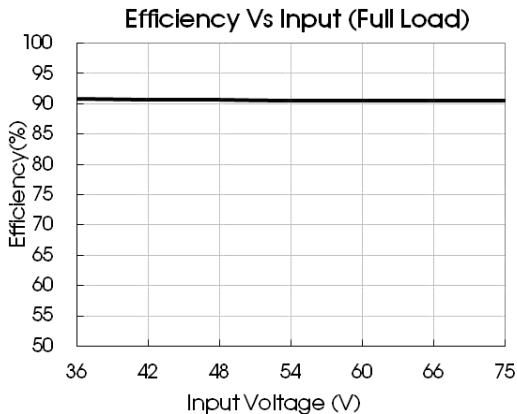
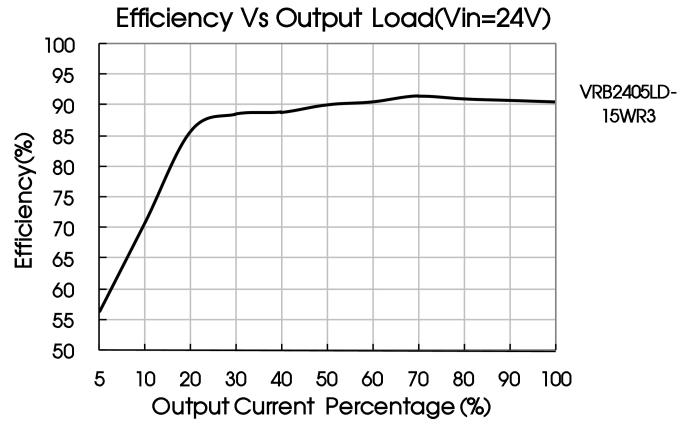
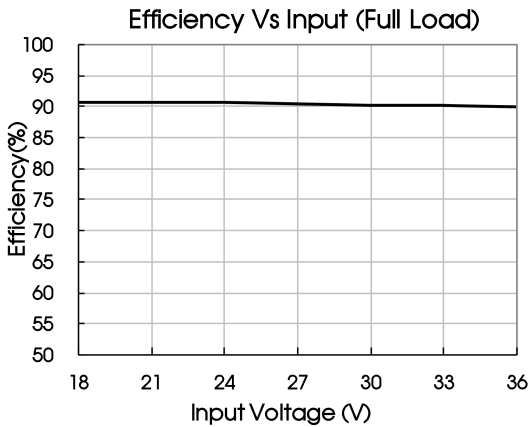

Fig. 1



Design Reference

1. Typical application

All the DC/DC converters of this series are tested before delivery using the recommended circuit shown in Fig. 2. Input and/or output ripple can be further reduced by appropriately increasing the input & output capacitor values Cin and Cout and/or by selecting capacitors with a low ESR (equivalent series resistance). Also make sure that the capacitance is not exceeding the specified max. capacitive load value of the product.

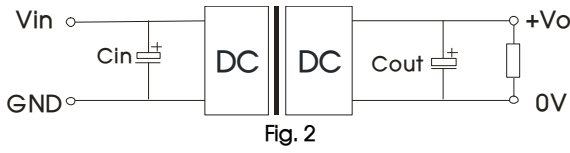

Vout (VDC)	Cout (μF)	Cin (μF)
3.3/5	470	100
12/15	220	
24	100	

2. EMC compliance circuit

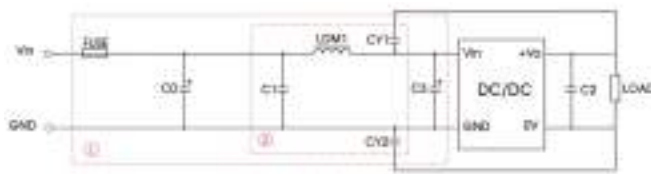

Notes: For EMC tests we use Part ① in Fig. 3 for immunity and part ② for emissions test. Selecting based on needs.

Parameter description

Model	Vin:24V	Vin:48V
FUSE	Choose according to actual input current	
C0/C3	330μF/50V	330μF/100V
C1	1μF/50V	4.7μF/100V
C2	Refer to the Cout in Fig.2	
LDM1	4.7μH/2.2A	
CY1/CY2	1nF/2KV	

3. Trim Function for Output Voltage Adjustment (open if unused)

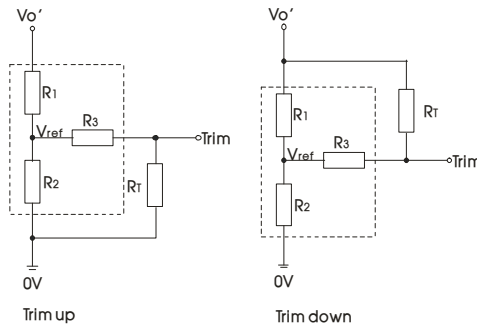

TRIM resistor connection (dashed line shows internal resistor network)

Calculating Trim resistor values:

$$\begin{aligned} \text{up: } R_T &= \frac{\alpha R_2}{R_2 - \alpha} - R_3 & \alpha &= \frac{V_{ref}}{V_{o'} - V_{ref}} \cdot R_1 \\ \text{down: } R_T &= \frac{\alpha R_1}{R_1 - \alpha} - R_3 & \alpha &= \frac{V_{o'} - V_{ref}}{V_{ref}} \cdot R_2 \end{aligned}$$

R<sub>T</sub> is Trim resistance  
α is a self-defined parameter, with no real meaning.

Vout(V)	R1(KΩ)	R2(KΩ)	R3(KΩ)	Vref(V)
3.3	4.801	2.87	12.4	1.24
5	2.883	2.87	10	2.5
12	11.000	2.87	15	2.5
15	14.494	2.87	15	2.5
24	24.872	2.87	17.8	2.5

4. The products do not support parallel connection of their output

5. For additional information please refer to DC-DC converter application notes on [www.mornsun-power.com](http://www.mornsun-power.com)

Horizontal Package (without heat sink) Dimensions and Recommended Layout

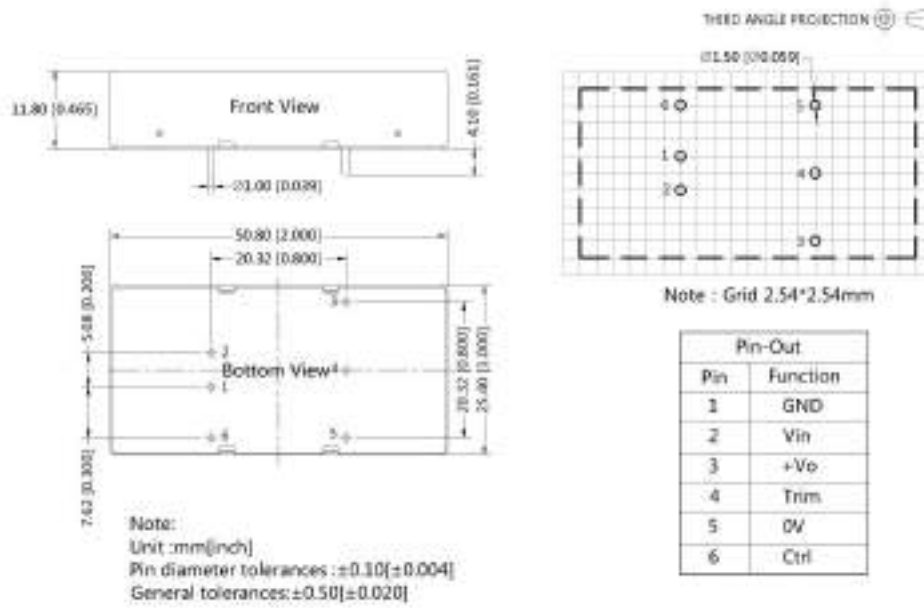

Horizontal Package (with heat sink) Dimensions

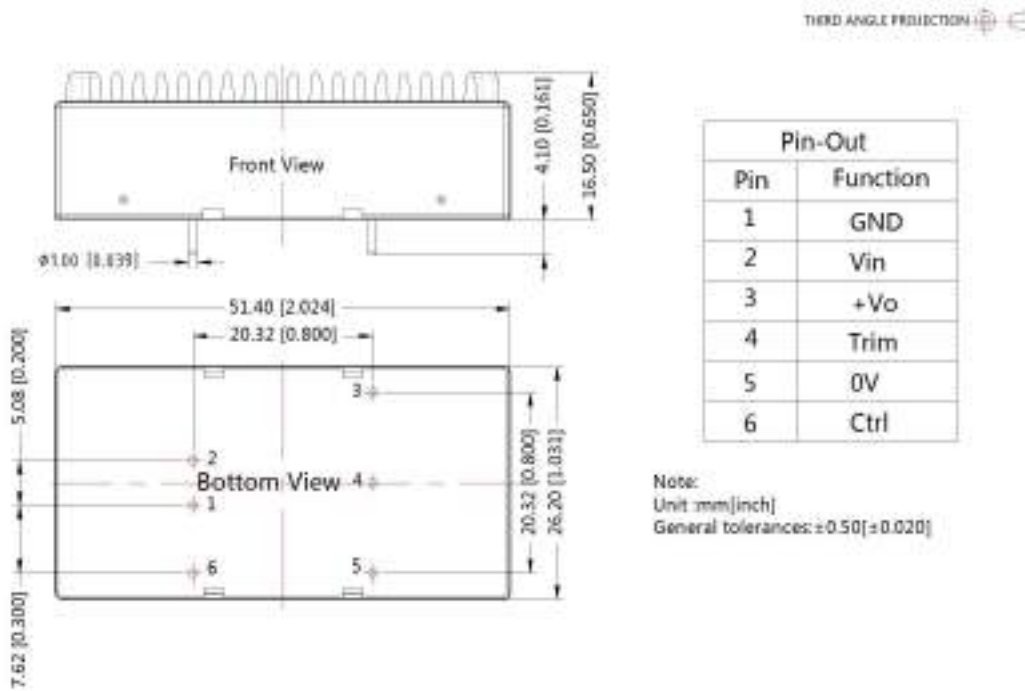

Note:

1. For additional information on Product Packaging please refer to [www.mornsun-power.com](http://www.mornsun-power.com). The Packaging bag number of Horizontal packaging: 58200035(without heat sink), 58200051(with heat sink);
2. The maximum capacitive load offered were tested at input voltage range and full load;
3. Unless otherwise specified, parameters in this datasheet were measured under the conditions of  $T_a=25^{\circ}\text{C}$ , humidity<75%RH with nominal input voltage and rated output load;
4. All index testing methods in this datasheet are based on company corporate standards;
5. We can provide product customization service, please contact our technicians directly for specific information;
6. Products are related to laws and regulations: see "Features" and "EMC";
7. Our products shall be classified according to ISO14001 and related environmental laws and regulations, and shall be handled by qualified units.

## Mornsun Guangzhou Science & Technology Co., Ltd.

Address: No. 5, Kehui St. 1, Kehui Development Center, Science Ave., Guangzhou Science City, Huangpu District, Guangzhou, P. R. China  
Tel: 86-20-38601850 Fax: 86-20-38601272 E-mail: [info@mornsun.cn](mailto:info@mornsun.cn) [www.mornsun-power.com](http://www.mornsun-power.com)