



厦门华联电子股份有限公司

Xiamen Hualian Electronics Corp., Ltd.

产品规格书

SPECIFICATION

产品名称：红外遥控接收放大器

DESCRIPTION: Infrared Module for Remote Control System

产品型号：HRM136AA1X00

PART NO.: HRM136AA1X00

拟制 Prepared	审核 Verified	批准 Approved

电话 Tel: 86-0592-2950777

传真 Fax: 86-0592-6037471

网址 Web: www.xmhl.com

地址：厦门市翔安区舩阳南路 189 号

Add: No.189,Fangyang South Road,Xiang'an District,Xiamen China

1 概述 General

红外遥控接收放大器是将光探测器与前置放大器封装在一起，以实现遥控信号的接收放大。环氧封装可滤除可见光干扰，检波输出信号可直接由微处理器译码。

Infrared module for remote control system which is PIN diode and preamplifier series are assembled on lead frame, in order to realize the receiving and amplifying the infrared remote controller signal. The type of epoxy package can filter the visual interference. The demodulated output signal can directly be decoded by a microprocessor.



图 1 产品图片

Figure1 Part photo

2 特点 Features

- 可靠性高 High reliability
- 无外围元件，内部屏蔽 No external parts, Inner discrete shield
- 载波频率 37.9kHz Carrier Frequency 37.9kHz
- 灵敏度高，传输范围远 High sensitivity, Large transmission range
- 对于环境光、电源杂讯和电磁场干扰有很强的抗扰性 High immunity against ambient light, power noise and electromagnetic interference
- 对于 wifi 干扰有很强的抗扰性 High immunity against wifi
- 低功耗 Low power consumption
- 最小脉冲宽度 $t_{Burst} \geq 12$ 载波周期（见图 2） Suitable minimum burst length $t_{Burst} \geq 12$ cycles of carrier (Figure2)
- 最小脉冲间隔 $t_{Gap} \geq 14$ 载波周期（见图 2） Suitable minimum burst gap time $t_{Gap} \geq 14$ cycles of carrier (Figure2)
- 最小信号间隔时间 $t_{Pause} \geq 25$ 毫秒（见图 3） Suitable minimum data pause time $t_{Pause} \geq 25$ ms (Figure3)
- 兼容 TTL&CMOS 电平 TTL & CMOS Compatibility
- 符合 RoHS 指令最新要求及 REACH 法规最新要求。Comply with the latest requirements of the RoHS directive and the latest requirements of REACH regulations.
- 静电防护等级：防静电等级 2000V（人体模式）ESD grade:2000V（HBM）

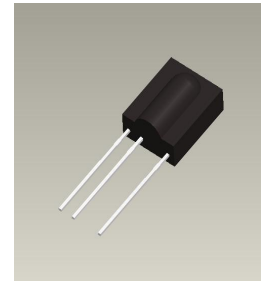

图 2 脉冲宽度和间隔时间

Figure 2 Pulse Length and Gap Time

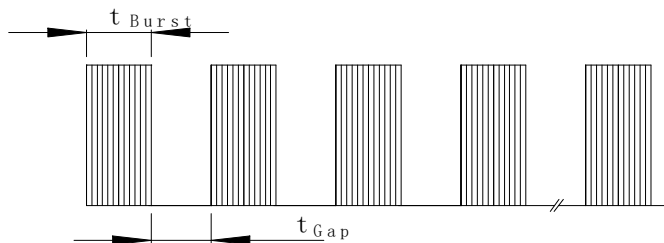

图 3 信号间隔时间 Figure3 Date Pause Time

3 应用 Applications

主要用于电视机、机顶盒、空调、智能电表、智能扫地机、智能垃圾桶、智能电水壶、遥控风扇、灯具等领域。

It may be used in TV sets, STB, air conditioners, Smart Meter, Cleaning Robot, Smart Trash Can, Smart Electric Kettle, Electric Fan lamps and lanterns etc.

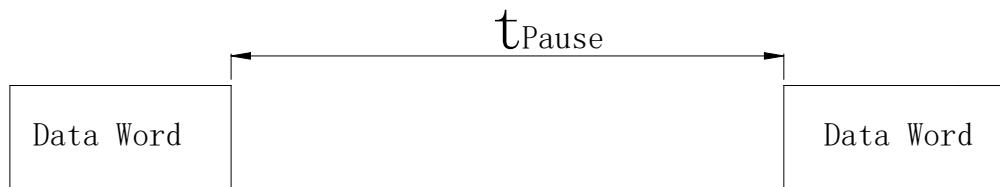
4 极限参数 Absolute Maximum Ratings

表 1 极限参数 Table 1 Absolute Maximum Ratings

参数 Parameters	符号 Symbol	额定值 Rated value	单位 Unit
电源电压 Supply voltage	V _{CC}	6.0	V
电源电流 Supply Current	I _{CC}	3.0	mA
输出电压 Output Voltage	V _O	6.0	V
输出电流 Output Current	I _O	2.5	mA
工作环境温度 Operating Ambiance Temperature.	T _{aop} ^b	-25~+85	°C
贮存温度 Storage Temp.	T _{stg}	-30~+85	°C
功率 Power Dissipation	P	18	mW
焊接温度 (10 秒) Soldering Temp. (10s) ^a	T _{slid}	+260	°C

^a 浸渍入离器件本体 2~2.5 毫米 Dip up to 2.0~2.5mm from the terminal root
^b 工作环境温度参数符号只在极限参数表中用 T_{aop} 表示, 其他地方用 T_a 表示
 Parameter symbol of Operating Ambiance Temperature uses T_{aop} only in Table Absolute Maximum Ratings, and uses T_a at other places.

5 光电参数 Opto-Electrical Characteristics

表 2 光电参数

Table2 Opto-Electrical Characteristics

T_a=25°C

参数 Parameters	符号 Symbol	测试条件 Test Condition	最小值 Min.	典型值 Typ.	最大值 Max.	单位 Unit
电源电流 Supply Current	I _{CC}	V _{CC} =3V E _v =0 E _e =0	0.1	0.23	0.4	mA
		V _{CC} =5V E _v =0 E _e =0	0.1	0.25	0.5	
峰值波长 Peak Wavelength	λ _P		-	940	-	nm
载波频率 Carrier Frequency	F _c	Internal BPF		36		kHz
高电平输出电压 High Output Voltage	V _{OH}	V _{CC} =5V or 3V E _e =2.0mW/ m ²	V _S -0.3	V _S	-	V
低电平输出电压 Low Output Voltage	V _{OL}		-	0.2	0.4	V
低电平输出脉宽 Low output pulse width ^c	T _{WL}	V _{CC} =5V or 3V IR LED: I _e =200mW/sr; P _w =600μs Duty=50%	450	600	750	μs
逻辑周期宽度 Logic Period width ^c	T _{WP}		1080	1200	1320	μs
接收距离 Receiving Distance	L	IR LED: I _e =200mW/ sr V _{CC} =5V or 3V; E _v =0 L _x	20	-	-	m
水平受控角 Horizontal Half Angle	θ _{1/2}	IR LED: I _e =200mW/sr; V _{CC} =5V or 3V; E _v =0 L _x L=10m	-	45	-	deg

°低电平脉宽、逻辑周期宽度 Low Output Pulse Width and Logic Period Width



图 4 低电平脉宽、逻辑周期宽度

Figure.4 Low Output Pulse Width and Logic Period Width

表 3 推荐工作条件 Table3 Recommended operating conditions Ta=25°C

参数 Parameter	符号 Symbol	工作条件 Operating conditions	单位 Unit
电源电压 Supply Voltage	Vcc	2.7~5.5	V

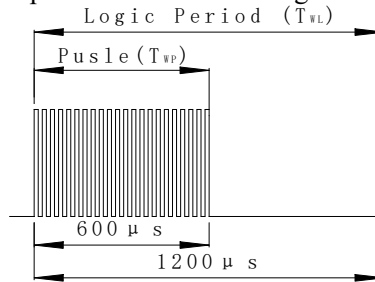
6 印章 Mark

在产品背面按如下打印产品型号和生产批号，

Print type model and LOT.NO. on the back of product as follow:

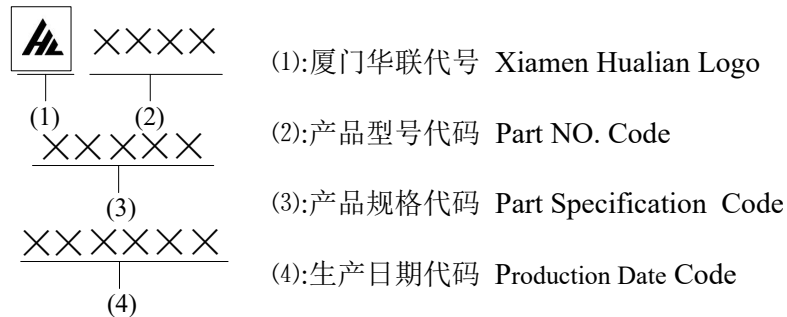

7 外形尺寸及电原理图 Dimensions and Circuit Diagram

● 内部框图 Block diagram



图 5 内部框图 Figure5 Block diagram

● 表 4 结构和材料 Table 4 Construction&Materials

序号 No.	名称 Name	材料 Material
1	粘合剂 Bond	银胶 Ag Paste
2	支架 Lead Frame	铁材 SPCC
3	塑封料 Molding	环氧材料 Epoxy Resin
4	光敏芯片 Photo diode	硅 Silicon
5	焊线 Bond Wire	金丝 Au Wire
6	IC 芯片 IC chip	硅 Silicon

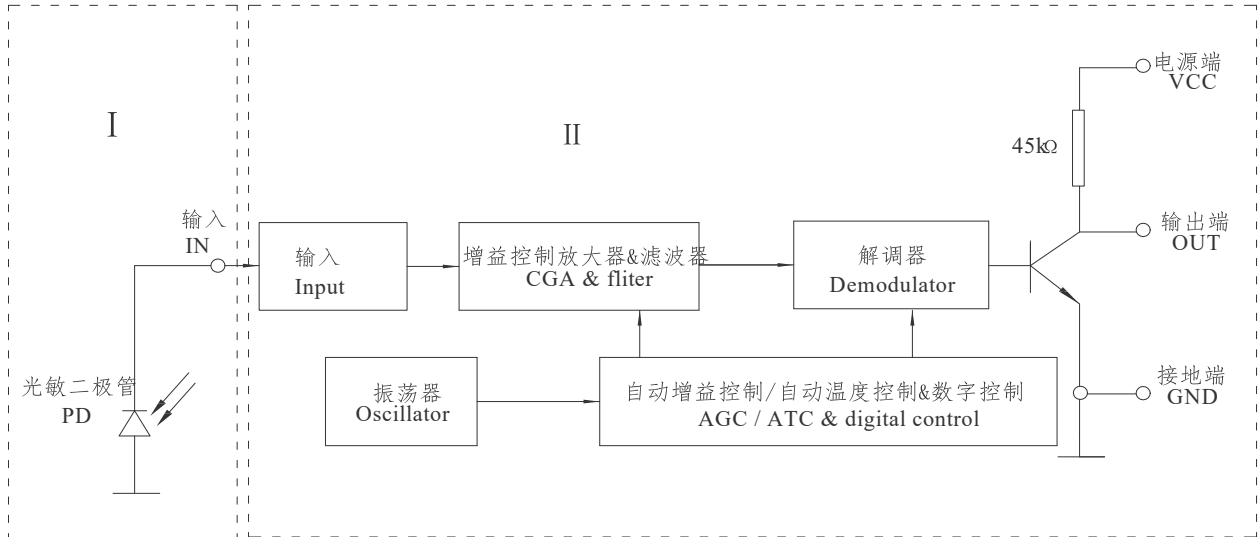

图 6 结构和材料
Figure6 Construction&Materials

● 外形图 Outline(单位 unit: 毫米 mm)

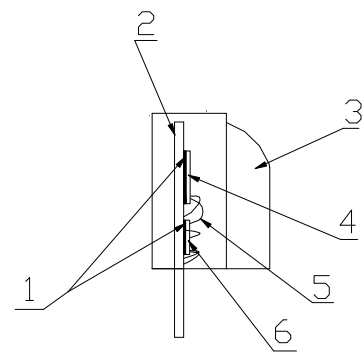

图7 外形尺寸 Figure 7 Dimension

8 特性曲线 Characteristics Curve



a) Frequency Dependence of Responsivity

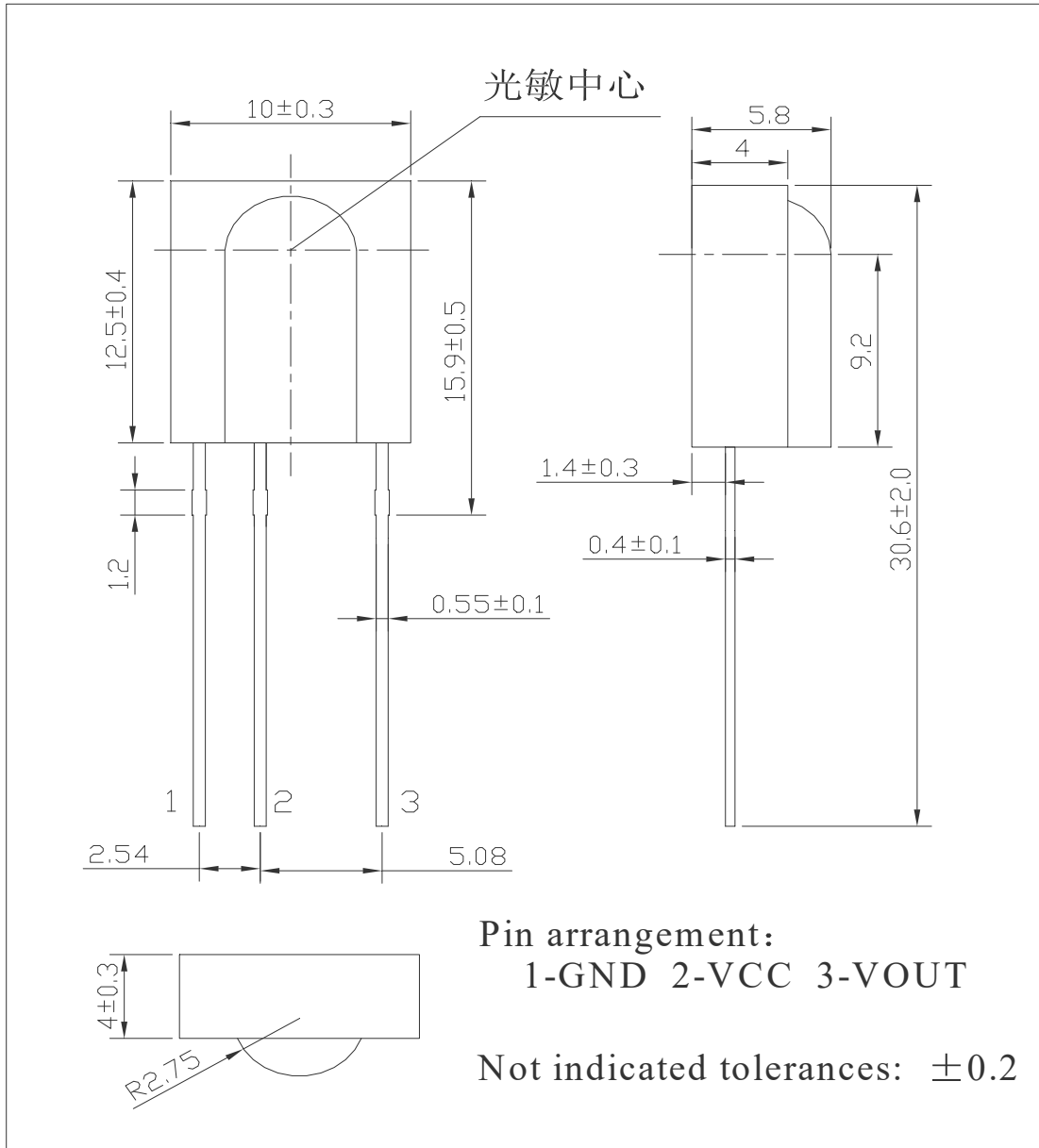
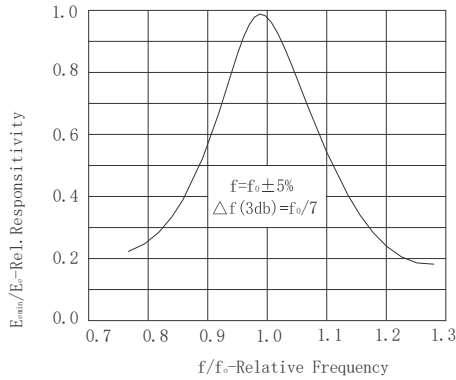
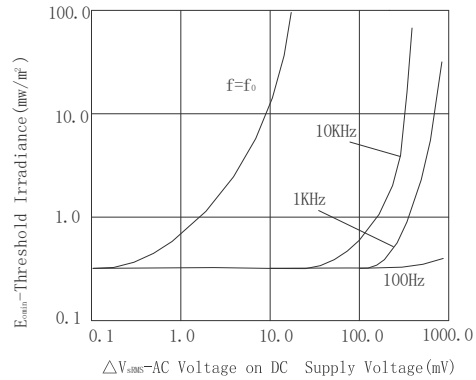

b) Sensitivity vs. Supply Voltage Disturbances

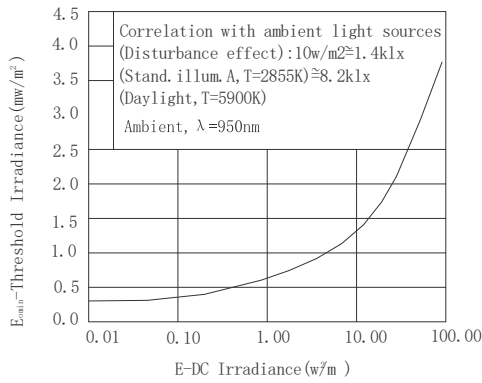

c) Sensitivity in Bright Ambient

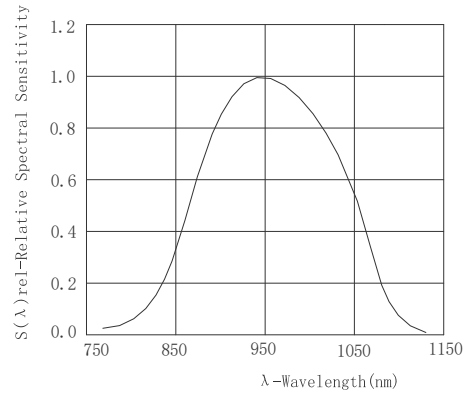

d) Relative Spectral Sensitivity vs. Wavelength

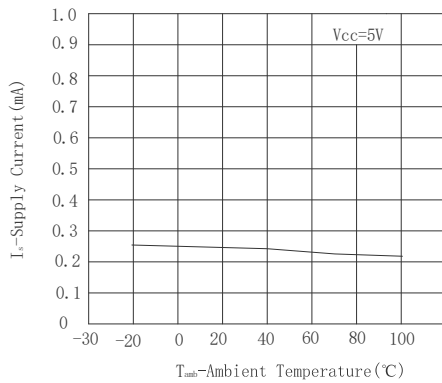

e) Supply Current vs. Ambient Temperature

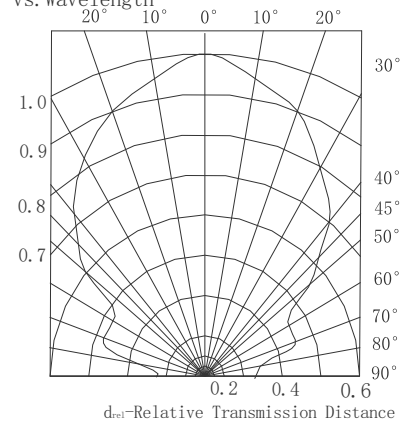

f) Directivity

图 8 特性曲线 Figure 8 Characteristics Curve

9 可靠性试验要求 Reliability Test

表 5 可靠性试验要求 Table5 Reliability Test

组别 No.	试验项目 Test Item	试验样品 Sample Number	试验条件 Test Conditions	指标 Request	[Ac, Re]
1	引出端拉力 Terminal Pull	16	外加力: 10N Pull: 10N 时间: 10 秒 Time: 10s	无损坏 No Damage	[0, 1]
	引出端弯曲强度 Terminal Intension	16	外加力: 2.5N 0° ~90° ~0° 弯曲 2 次。 Pull: 2.5N 0°~90°~0° Bend 2 times.	无损坏 No Damage	[0, 1]
2	可焊性 Solder Ability	16	温度: (245±5) °C Temperature: (245±5) °C. 时间: (2±0.5) 秒 浸入离器件本体 (1.0~1.2) mm。 Times:(2±0.5)s Dip up to 1.0~1.2mm from the terminal root. 焊剂: 无铅焊锡 Sn(95% ~ 96.5%)/Ag(3% ~ 4%)/Cu(0.5%~1.0%) Flux: No Pb soldering Sn(95% ~ 96.5%)/Ag(3%~4%)/Cu(0.5%~1.0%). 助焊剂: 松香 25%, 酒精 75%。 Help Flux: 75% isopropyl alcohol, 25% resin.	浸润面积≥ 浸渍面积的 95% Soakage Area≥95 percent of dip area.	[0, 1]
	耐焊接热 Thermal Weld	16	波峰焊: 焊锡温度 (260±5) °C, 浸渍时间 (10±1) 秒, 浸渍到离器件本体(2~2.5)mm, 焊剂: 无铅焊锡 Sn(95%~96.5%)/Ag(3%~4%)/Cu(0.5%~1.0%), 助焊剂: 松香 25%, 酒精 75%。 Wave soldering: Temperature: (260±5)°C, Immersed for (10±1)sec.(2.0~2.5)mm away from the body. Flux: No Pb soldering: Sn(95%~96.5%)/Ag(3%~4%)/Cu(0.5%~1.0%). Help Flux: 75% isopropyl alcohol, 25% resin.	试验完成后, 试验样品在标准大气条件下恢复 4h 后, 在 4h 内测试光电参数应符合表 2 的规定。 Finish a test of optoelectronics within four hours after renew four hours.	[0, 1]
16		烙铁焊: 焊锡温度 (350±5) °C, 浸渍时间 (10±1) 秒, 焊剂: 无铅焊锡 Sn(95%~96.5%)/Ag(3%~4%)/Cu(0.5%~1.0%), 助焊剂: 松香 25%, 酒精 75%。 Soldering iron: Temperature head of soldering iron:(350±5)°C; soldering time:(10±1) sec; Flux: No Pb soldering: Sn(95%~96.5%)/Ag(3%~4%)/Cu(0.5%~1.0%). Help Flux: 75% isopropyl alcohol, 25% resin.	[0, 1]		
3	快速温度变化及交变湿热 Temperature Fast Changing and Heat Humidity Cycling	12	TA= (-25±2) °C, TB= (85±2) °C, 暴露时间: 10 分钟, 转移时间: (2-3) 分钟, 循环次数: 5 次, 恢复时间 2h 后继之于循环湿热, 试验严酷度: T= (55±2) °C, 湿度: (90~95)%; 循环次数: 2 次 TA= (-25±2) °C, TB= (85±2) °C, Exposure Time: 10mins; Transferring Time: 2~3mins; Cycle times:5 Cycles; Following the Heat Humidity Cycling after renew 2 hours: asperity degree: T= (55±2) °C, humidity: (90~95)%, 2 Cycles.		[0, 1]
4	电耐久试验 Operating Life	25	温度: (25±3) °C 通电电压: 5V Ee=2mW/cm² 时间: 1000 小时。 T= (25±3) °C, Vs=5V; Ee=2mW/cm², t=1000h.		[0, 1]
5	高温贮存 High Temperature Storage	16	温度: (85±2) °C, 时间: 1000 小时。 T: (85±2) °C, t: 1000h.		[0, 1]
	低温贮存 Low Temperature Storage	16	温度: (-25±2) °C, 时间: 168 小时。 T: (-25±2) °C, t: 168h.		[0, 1]

10 包装方式 Packing

包装采用防静电塑料条管和外包装纸箱，外包装箱上应有符合 GB191 中规定的相应运输要求的标志以及标明公司名称、商标、地址、产品名称、型号、数量等，并贴有封讫，箱内应有合格证，标明型号、生产日期及检验员代号等。

The parts are put into antistatic plastic tubes which are packed in cartons. On the carton, followings are printed: mark of transportation stipulated in GB191, Company Name, Trade mark, Address, Product Description, Model and Quantity. Sealing mark is stuck on the carton too. Inside the carton there are qualification certificate, stated model, production date and inspector's code.

10.1 内包装采用防静电条管包装，50 只/条

Internally packed with antistatic plastic tube, 50pcs/tube.



图 9 内包装塑料条管 Figure 9 Internally plastic tube

10.2 外包装用纸箱 528mm×230mm×250mm，8000 只/箱。

Externally packed with 528mm×230mm×250mm cartons, 8000 pcs/carton.

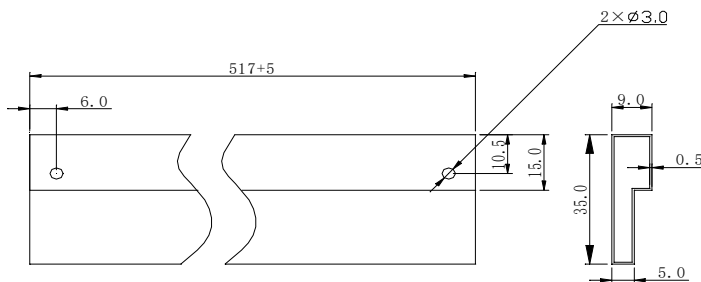

图 10 外包装箱 Figure 10 Externally cartons

10.3 标识 Label。

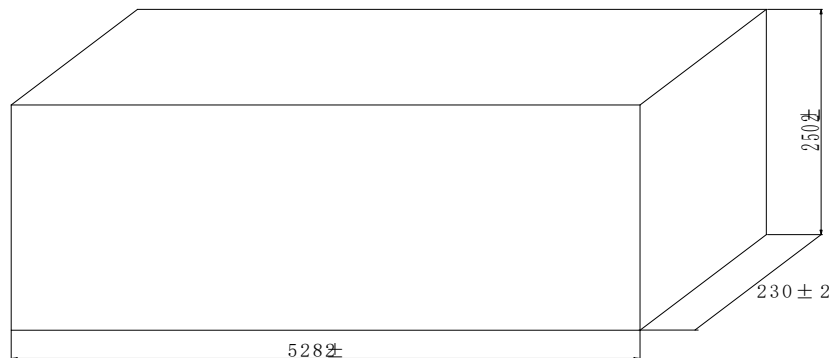

图 11 标识 Figure 11 Label

11 使用注意事项 Precautions for Use

11.1 该产品为静电敏感元件，要求使用时人和所有的装置(包括烙铁)、设备、机器、桌子、地面等都必须采取防静电措施。

Since the device is static sensitive, it is requested that anti-static measures should be taken on human body and all devices (including soldering iron) and equipment, machinery, desk and ground.

11.2 不要对引脚施加不必要的外力。Do not apply unnecessary stress to lead.

11.3 注意保护接收器的接收面，沾污后会影响到接收性能，同时不要触碰接收表面。

Please pay attention to the lens of receivers, It might affect the performance if it gets dirty, don't touch the receiving surface either.

11.4 在外部电路上必须加上限流电阻，避免出现浪涌电流对器件造成破坏。

Current limited resistor should be added to the peripheral circuit to avoid shock of powerful current.

11.5 适合的红外编码格式: NEC code, RC5 code; Toshiba Code;

Suitable IR data format: NEC code, RC5 code; Toshiba Code;

11.6 红外遥控接收放大器的解码性能，包括对遥控器的发射信号正确解码以及解码的质量（输出脉宽和周期的宽度，干扰信号输出等）均受应用条件（红外编码格式，发射信号强度、负载及滤波等外围电路、干扰、软件设定等）因素的影响。如果这些应用条件变化，红外遥控接收放大器有可能输出不正确的信号，将会导致设备不能遥控，或遥控不灵敏。因此每一个机型在批量使用红外遥控接收放大器前，都必须在所用的机型上进行样品和小批量产品的验证。

The performance of IR receiver's demodulated output signal, which decode the controller's signal correctly and the quality of the output signal (such as the width of output pulse and period, output interference signal, etc), has close relations with the conditions of application(IR code, the radiation intensity of controller, external circuit about load and filter, interference, the setting of soft program about demodulated IR code, etc). If the conditions of application have been changed, the IR receiver maybe output signal incorrectly. It will lead to the equipment has not been controlled or does not respond to the control every time. So the customer must to test and verify the samples and a little batch of product in every model of equipment before the large batch of product to be used.

11.7 在不同工作电压下，产品的解码性能，包括对遥控器的发射信号正确解码以及解码的质量（输出脉宽和周期的宽度，干扰信号输出等）能否正常解码及其解码质量（改变脉宽宽度，有干扰信号等）会有所差异。当工作电压变化到一定程度时，红外遥控接收放大器有可能输出不正确的信号，将会导致设备不能遥控，或遥控不灵敏。因此在工作电压非 5V 时，每一个机型在批量使用红外遥控接收放大器前，都必须在所用的机型上进行样品和小批量产品的验证。

The performance of IR receiver's demodulated output signal, which decode the controller's signal correctly and the quality of the output signal (such as the width of output pulse and period, output interference signal, etc) differ from varied supply voltage. When the supply voltage has been changed, the IR receiver maybe output signal incorrectly. It will lead to the equipment has not been controlled or does not respond to the control every time. When the supply voltage isn't 5V, the customer must to test and verify the samples and a little batch of product in every model of equipment before the large batch of product to be used.

11.8 推荐电路 Recommended circuit



图 12 推荐电路 Figure12 Recommended Circuit

11.9 推荐焊接条件 Recommended soldering conditions

10.9.1 施加在环氧树脂上的温度不要超过最高贮存温度。

Not to apply high temperature exceeding the maximum storage temperature to the epoxy resin.

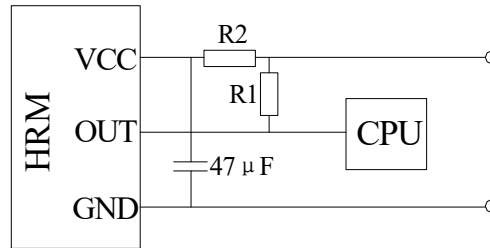
10.9.2 在高温下不要对环氧树脂施加压力

Not to apply any force to the epoxy resin at high temperature.

10.9.3 焊接过程 Soldering process

(1)元器件的焊盘焊接区的插孔间距必须一致，以避免在焊接过程中出现应力，这会导致器件开路。并且必须在焊接前进行器件引脚成形，引脚成形过程中不要对环氧体内部施加压力。

The distance between holes should be the same as that of between terminal lands of the component to avoid any stress during the soldering process. This may lead to the open circuit. Also, lead forming should be done before soldering process not to apply any stress to the inside of the epoxy resin.

(2)在焊接过程中不要对器件施加任何压力

Not to apply any stress to the component during the soldering process.

(3)推荐焊接条件 Recommended soldering condition

表7 推荐焊接条件 Table7 Recommended soldering condition

	条件Condition
预热温度和焊锡槽温度 Pro-heating & solder bath	预热：小于90度 Pro-heating: less than 90℃ 焊锡槽温度：260度 Solder bath:260℃ 浸渍入离器件环氧体底部3毫米；浸渍时间：小于5s；次数小于2次 Soldering area: 3mm away from the bottom the epoxy resin. Dip time: less than 5 seconds, less than twice.
烙铁焊接 Soldering iron	烙铁温度小于350度，次数2次，每次时间3秒 Temperature: Less than 350℃, within 3 seconds, 2 times 烙铁离环氧体底部3毫米 Soldering area: 3mm away from the bottom of the epoxy resin.

11.10 清洗 washing

一些化学试剂会破坏环氧树脂

Some chemicals may damage the epoxy resin.

推荐按下列条件使用乙醇清洗

Ethyl alcohol is recommended under the following condition.

表8 推荐清洗条件 Table 8 Recommended washing condition

化学清洗 Chemical washing	温度小于45度 Temperature: less than 45°C 清洗时间小于3分钟 Wash time: less than 3 minutes.
超声波清洗 Ultrasound washing	功率小于15 W/L Power: less than 15W/L 清洗时间小于3分钟 Wash time: Less than 3 minutes

12 申明 Statement

12.1 后续由于提高产品的可靠性、功能或者是设计引起的所有产品的规格以及产品的数据资料更改将不再做另行通知。

All product, product specification and data may be changed without notice to improve reliability, Function or design.

12.2 规格书所述只是针对于规格书上所列的产品，产品在常规运用上的性能优良，比如机顶盒，电视机，空调等，无法保证产品在特殊运用上的可行性。

The datasheet is only suitable for the product showed in the specification. The product show well performance on common such as set-box, television, air conditioners ,etc. HuaLian makes no warranty, representation or guarantee regarding the suitability of the products for any particular purpose.

12.3 为最大程度上遵守法律法规，华联对产品应用引起的法律责任不做负责。

To the maximum extent permitted by applicable law, HuaLian disclaims any and all liability arising out of the application or use of any product.

12.4 华联的产品不设计为医疗，急救，或是其他有可能由于失效而引起伤害或者是生命危险的运用。

Hualian products are not designed for use in medical, life-saving, or life-sustaining, applications or for any other application in which the failure of the Vishay product could result in personal injury or death.