

FYL-5019EGW1B

Features:

- High intensity
- General purpose leads
- RoHs complant.

Descriptions:

- Dice material E: GaP
G: GaP
- Emitting Color E: Orange
G: Yellow Green
- Device Outline: $\Phi 5\text{mm}$ Round Type.
- Lens Type: White diffused.

Radiation pattern.

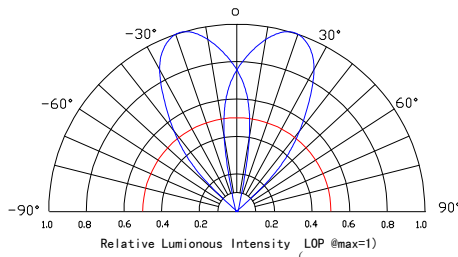

Package configuration

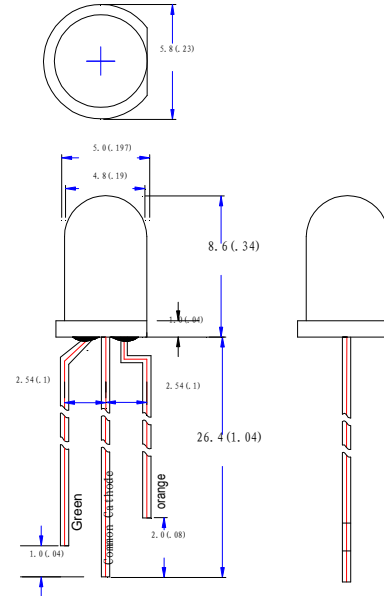

- ◆ All dimensions are millimeters (inches)
- ◆ Tolerance is $\pm 0.25\text{mm}(.010\text{'})$ unless otherwise noted.

Absolute maximum ratings($T_a=25^\circ\text{C}$)

| Parameter | MAX. | | Unit |
|---|---------------------|----|-------|
| Power Dissipation | E | 50 | mW |
| | G | 50 | |
| Peak Forward Current (1/10 Duty Cycle, 0.1ms Pulse Width) | 100 | | mA |
| Continuous Forward Current | 20 | | mA |
| Derating Linear From 50°C | 0.4 | | mA/°C |
| Reverse Voltage | 5 | | V |
| Operating Temperature Range | -30°C to +80°C | | |
| Storage Temperature Range | -40°C to +100°C | | |
| Lead Soldering Temperature[4mm(.157") From Body] | 260°C for 5 Seconds | | |

Electrical and optical characteristics(Ta=25 °c)

| Parameter | Symbol | Min. | Typ. | Max. | Unit | Test Condition |
|--------------------------|-------------------|------|------|------|------|--------------------|
| Luminous Intensity | I _v | E | - | 50 | - | mcd |
| | | G | - | 58 | - | |
| Viewing Angle | 2θ _{1/2} | E | 45 | 50 | 55 | Deg |
| | | G | 45 | 50 | 55 | |
| Peak Emission Wavelength | λ _p | E | 625 | 630 | 635 | nm |
| | | G | 563 | 568 | 573 | |
| Dominant Wavelength | λ _d | E | 620 | 625 | 630 | nm |
| | | G | 567 | 572 | 577 | |
| Spectral Line Half-Width | Δλ | E | 10 | 15 | 20 | nm |
| | | G | 15 | 20 | 25 | |
| Forward Voltage | V _F | E | 1.8 | 2.3 | 2.5 | V |
| | | G | 1.8 | 2.3 | 2.5 | |
| Reverse Current | I _R | | - | 50 | μA | V _R =5V |

Typical Electrical Characteristics Curves (25 °c Ambient Temperature Unless Otherwise Noted)

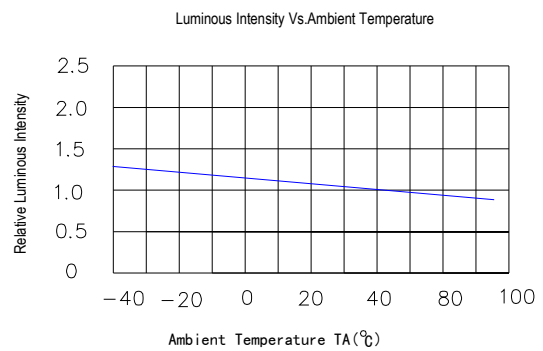
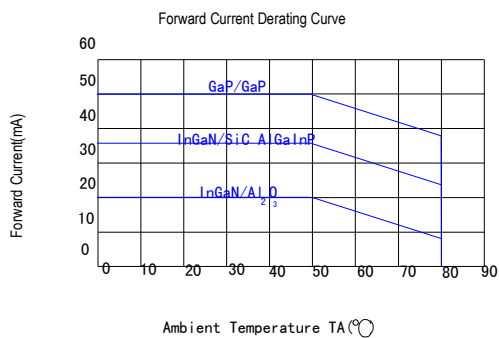
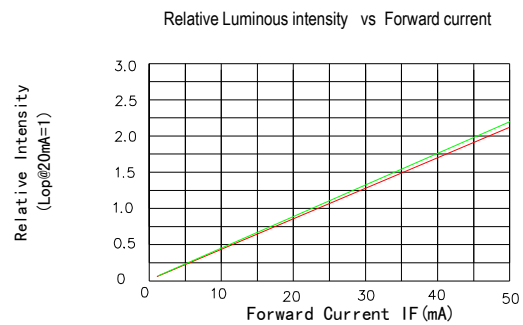
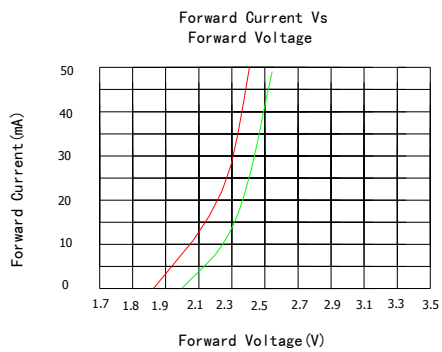
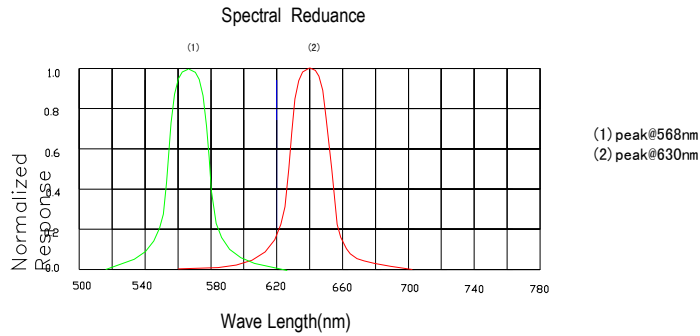

LAMP PACKING.

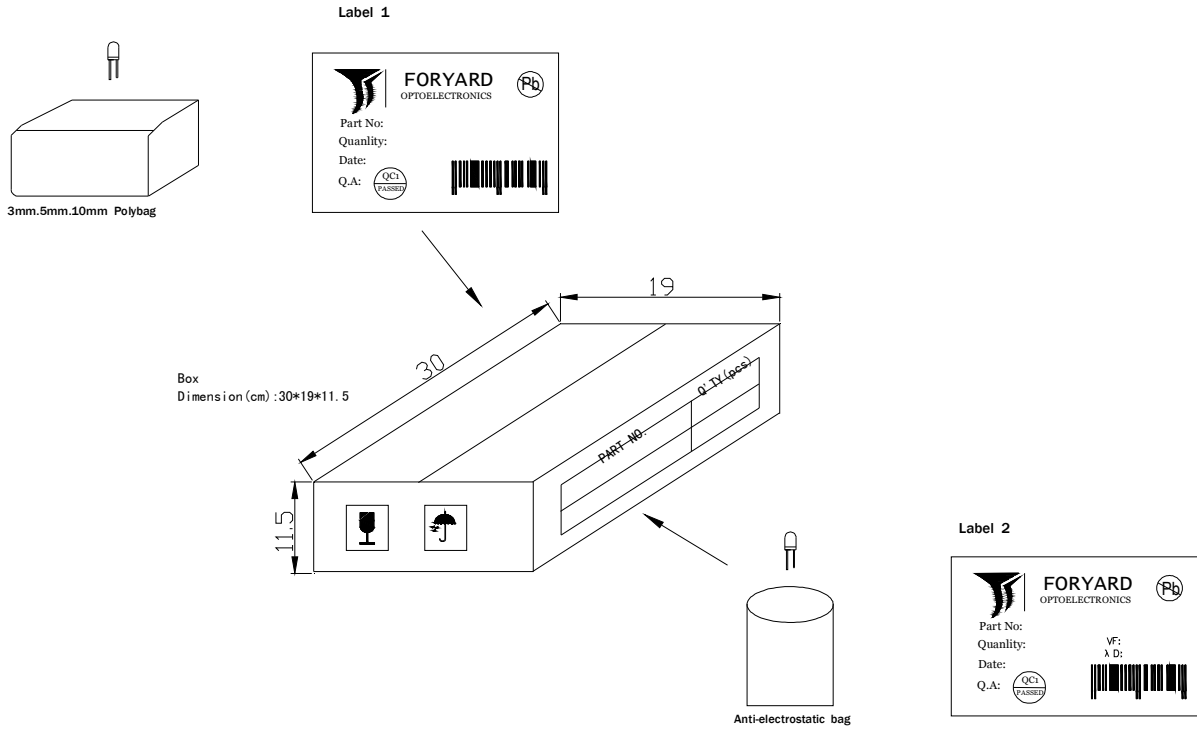

| DEVICE | QTY/polybag(pcs) | Polybag/box A | Fig |
|------------------|------------------|---------------|---------|
| 5mm(T-1 3/4) | 1000 | 8 bags | Label 1 |
| 3mm(T-1) | 1000 | 10 bags | Label 1 |
| 10mm(T-1) | 250 | 8 bags | Label 1 |
| Blue/Green/White | 500pcs | 8 bags | Label 2 |

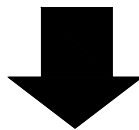

CARTON
Dimension(cm):39*32*38

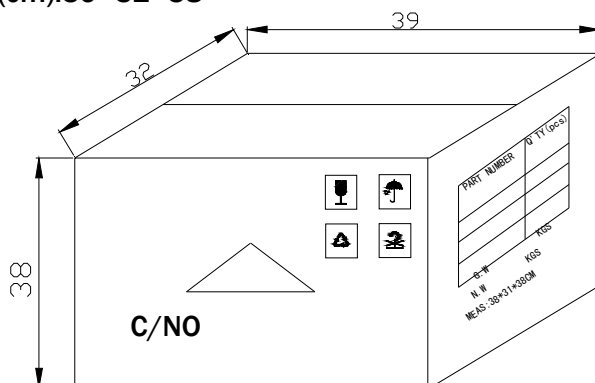

6 Boxes/Carton
 5mm:48,000pcs
 3mm:60,000pcs
 10mm:12,000pcs
 Blue/Pure Green/bluish Green
 /White:24,000pcs